

PR-X

3A7526H

Fixed Ratio System

EN

For accurate metering, mixing, and dispensing of two-component materials. For professional use only.

Not approved for use in explosive atmospheres or hazardous (classified) locations.

1200 psi (8.3 MPa, 83 bar) Maximum Working Pressure

100 psi (0.7 MPa, 7 bar) Maximum Air Inlet Pressure



Important Safety Instructions

Read all warnings and instructions in this manual before using the equipment. Save these instructions.

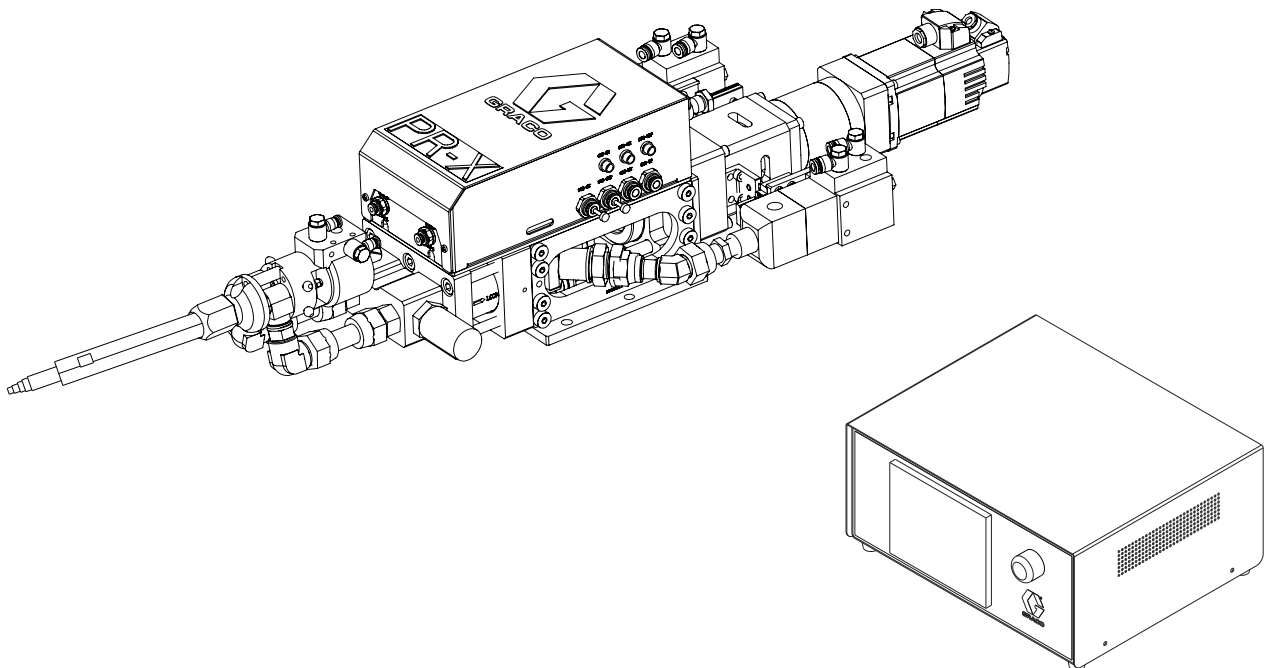

Contents

Related Manuals	3	Repair	52
Models	3	Prepare Machine for Piston/Cylinder Replacement Kit Installation	52
Safety Symbols	4	Disassemble Cylinder	53
General Warnings	5	Install Cylinder	53
Keep Components A and B Separate	7	Prepare Machine for Operation	53
Changing Materials	7	Parts	54
Typical Installation	8	Overview	54
Component Identification	9	PR-X System, Pump Feed, Direct, 25R128, 25R129, 2001180, 2001181, 2003138, 2005007 and 2005008	55
PR-X Metering Unit, Pump Feed	9	PR-X Base Assembly, Pump Feed	56
PR-X Control Unit	10	Supply Pump Assembly	69
General Information	11	Kits and Accessories	71
Installation	12	SD Card	71
Unpacking	12	Cord set	71
Locate and Install	13	Cable	71
Grounding	14	Mixer	71
System Connections	15	Shroud	71
Flush Before Using Equipment	15	O-Ring	71
HMI Display Operation and Identification	16	Remote Kit	72
Screen Navigation Diagrams	16	Dimensions	73
Automatic Screen 1	19	PR-X Metering Unit, Pump Feed	73
Automatic Screen 2	21	PR-X Control Unit	73
Automatic Screen 3	22	Schematics	74
Automatic Screen 4	24	I/O signals	79
Automatic Screen 5	25	Profinet Map	80
System Main Screen	26	Timing Chart	81
System Information Screen	26	Technical Specifications	82
Manual Screen 1	27	California Proposition 65	83
Manual Screen 2	28	Graco Standard Warranty	84
Setup Screen	28		
Advanced Screen 1	37		
Advanced Screen 2	38		
Operation	39		
Startup	39		
Prime the System	40		
Ratio Check Procedure	41		
Shutdown	41		
Pressure Relief Procedure	42		
Flush the Equipment	42		
Software Setup (For Profinet Communication Mode Only)	43		
Maintenance	47		
Preventive Maintenance	47		
Recycling and Disposal	48		
End of Product Life	48		
Troubleshooting	49		

Related Manuals

Manuals in English	Description
312185	MD2 Dispense Valve Instructions and Parts Manual
308876	1K Ultra-Lite™ Instructions and Parts List Manual

Models

Part	Maximum Working Pressure psi (MPa, bar)	Description
25R128	1200 psi (8.3 MPa, 83 bar)	PR-X System, Pump Feed, Direct, SST ⁽¹⁾ , 50 CC, 1:1, I/O
25R129	1200 psi (8.3 MPa, 83 bar)	PR-X System, Pump Feed, Direct, HW ⁽²⁾ , 50 CC, 1:1, I/O
2001180	1200 psi (8.3 MPa, 83 bar)	PR-X System, Pump Feed, Direct, SST ⁽¹⁾ , 37 CC, 2:1, I/O
2001181	1200 psi (8.3 MPa, 83 bar)	PR-X System, Pump Feed, Direct, HW ⁽²⁾ , 37 CC, 2:1, I/O
2003138	1200 psi (8.3 MPa, 83 bar)	PR-X System, Pump Feed, Direct, SST ⁽¹⁾ , 25 CC, 1:1, I/O
2005007	1200 psi (8.3 MPa, 83 bar)	PR-X System, Pump Feed, Direct, SST ⁽¹⁾ , 50 CC, I/O, 1:1, 10 m
2005008	1200 psi (8.3 MPa, 83 bar)	PR-X System, Pump Feed, Direct, HW ⁽²⁾ , 50 CC, I/O, 1:1, 10 m

⁽¹⁾ SST: Stainless steel material

⁽²⁾ HW: High wear resistant abrasive material

NOTE: Any PR-X system can be converted to use Profinet communication mode. Order SD card 18C277 and perform **Software Setup (For Profinet Communication Mode Only)** on page 43. And any PR-X system can be converted to remote version, please order **Remote Kit** on page 72.

NOTE: If you want to order other ratio systems (1:1 - 2.4:1), please contact Graco sales representative for a custom solution.

Safety Symbols

The following safety symbols appear throughout this manual and on warning labels. Read the table below to understand what each symbol means.

Symbol	Meaning
	Electric Shock Hazard
	Equipment Misuse Hazard
	Fire and Explosion Hazard
	Moving Parts Hazard
	Skin Injection Hazard
	Skin Injection Hazard
	Toxic Fluid or Fumes Hazard

Symbol	Meaning
	Do Not Place Hands or Other Body Parts Near Fluid Outlet
	Do Not Stop Leaks with Hand, Body, Glove or Rag
	Eliminate Ignition Sources
	Ground Equipment
	Follow Pressure Relief Procedure
	Ventilate Work Area
	Wear Personal Protective Equipment













Safety Alert Symbol









This symbol indicates: Attention! Become Alert! Look for this symbol throughout the manual to indicate important safety messages.

General Warnings



The following warnings apply throughout this manual. Read, understand, and follow the warnings before using this equipment. Failure to follow these warnings can result in serious injury.

 <h2 style="margin: 0;">WARNING</h2>	
 	<p>ELECTRIC SHOCK HAZARD</p> <p>This equipment must be grounded. Improper grounding, setup, or usage of the system can cause electric shock.</p> <ul style="list-style-type: none"> • Turn off and disconnect power at main switch before disconnecting any cables and before servicing or installing equipment. • Connect only to grounded power source. • All electrical wiring must be done by a qualified electrician and comply with all local codes and regulations.
    	<p>SKIN INJECTION HAZARD</p> <p>High-pressure fluid from dispensing device, hose leaks, or ruptured components will pierce skin. This may look like just a cut, but it is a serious injury that can result in amputation. Get immediate surgical treatment.</p> <ul style="list-style-type: none"> • Do not point dispensing device at anyone or at any part of the body. • Do not put your hand over the fluid outlet. • Do not stop or deflect leaks with your hand, body, glove, or rag. • Follow the Pressure Relief Procedure when you stop dispensing and before cleaning, checking, or servicing equipment. • Tighten all fluid connections before operating the equipment. • Check hoses and couplings daily. Replace worn or damaged parts immediately.
	<p>TOXIC FLUID OR FUMES HAZARD</p> <p>Toxic fluids or fumes can cause serious injury or death if splashed in the eyes or on skin, inhaled, or swallowed.</p> <ul style="list-style-type: none"> • Read Safety Data Sheets (SDSs) to know the specific hazards of the fluids you are using. • Store hazardous fluid in approved containers, and dispose of it according to applicable guidelines.
	<p>PERSONAL PROTECTIVE EQUIPMENT</p> <p>Wear appropriate protective equipment when in the work area to help prevent serious injury, including eye injury, hearing loss, inhalation of toxic fumes, and burns. Protective equipment includes but is not limited to:</p> <ul style="list-style-type: none"> • Protective eyewear, and hearing protection. • Respirators, protective clothing, and gloves as recommended by the fluid and solvent manufacturer.

WARNING

   	<p>FIRE AND EXPLOSION HAZARD</p> <p>Flammable fumes, such as solvent and paint fumes, in work area can ignite or explode. Paint or solvent flowing through the equipment can cause static sparking. To help prevent fire and explosion:</p> <ul style="list-style-type: none"> • Use equipment only in well-ventilated area. • Eliminate all ignition sources; such as pilot lights, cigarettes, portable electric lamps, and plastic drop cloths (potential static sparking). • Ground all equipment in the work area. See Grounding instructions. • Never spray or flush solvent at high pressure. • Keep work area free of debris, including solvent, rags and gasoline. • Do not plug or unplug power cords, or turn power or light switches on or off when flammable fumes are present. • Use only grounded hoses. • Hold gun firmly to side of grounded pail when triggering into pail. Do not use pail liners unless they are anti-static or conductive. • Stop operation immediately if static sparking occurs or you feel a shock. Do not use equipment until you identify and correct the problem. • Keep a working fire extinguisher in the work area.
 	<p>EQUIPMENT MISUSE HAZARD</p> <p>Misuse can cause death or serious injury.</p> <ul style="list-style-type: none"> • Do not operate the unit when fatigued or under the influence of drugs or alcohol. • Do not exceed the maximum working pressure or temperature rating of the lowest rated system component. See Technical Specifications in all equipment manuals. • Use fluids and solvents that are compatible with equipment wetted parts. See Technical Specifications in all equipment manuals. Read fluid and solvent manufacturer's warnings. For complete information about your material, request Safety Data Sheets (SDSs) from distributor or retailer. • Turn off all equipment and follow the Pressure Relief Procedure when equipment is not in use. • Check equipment daily. Repair or replace worn or damaged parts immediately with genuine manufacturer's replacement parts only. • Do not alter or modify equipment. Alterations or modifications may void agency approvals and create safety hazards. • Make sure all equipment is rated and approved for the environment in which you are using it. • Use equipment only for its intended purpose. Call your distributor for information. • Route hoses and cables away from traffic areas, sharp edges, moving parts, and hot surfaces. • Do not kink or over bend hoses or use hoses to pull equipment. • Keep children and animals away from work area. • Comply with all applicable safety regulations.
 	<p>MOVING PARTS HAZARD</p> <p>Moving parts can pinch, cut or amputate fingers and other body parts.</p> <ul style="list-style-type: none"> • Keep clear of moving parts. • Do not operate equipment with protective guards or covers removed. • Equipment can start without warning. Before checking, moving, or servicing equipment, follow the Pressure Relief Procedure and disconnect all power sources.

Keep Components A and B Separate

				
<p>Cross-contamination can result in cured material in fluid lines which could cause serious injury or damage equipment. To prevent cross-contamination:</p> <ul style="list-style-type: none">• Never interchange component A and component B wetted parts.• Never use solvent on one side if it has been contaminated from the other side.				

Changing Materials

NOTICE
<p>Changing the material types used in your equipment requires special attention to avoid equipment damage and downtime.</p> <ul style="list-style-type: none">• When changing materials, flush the equipment multiple times to ensure it is thoroughly clean.• Always clean the fluid inlet strainers after flushing.• Check with your material manufacturer for chemical compatibility.• When changing between epoxies and urethanes or polyureas, disassemble and clean all fluid components and change hoses. Epoxies often have amines on the B (hardener) side. Polyureas often have amines on the B (resin) side.

Typical Installation

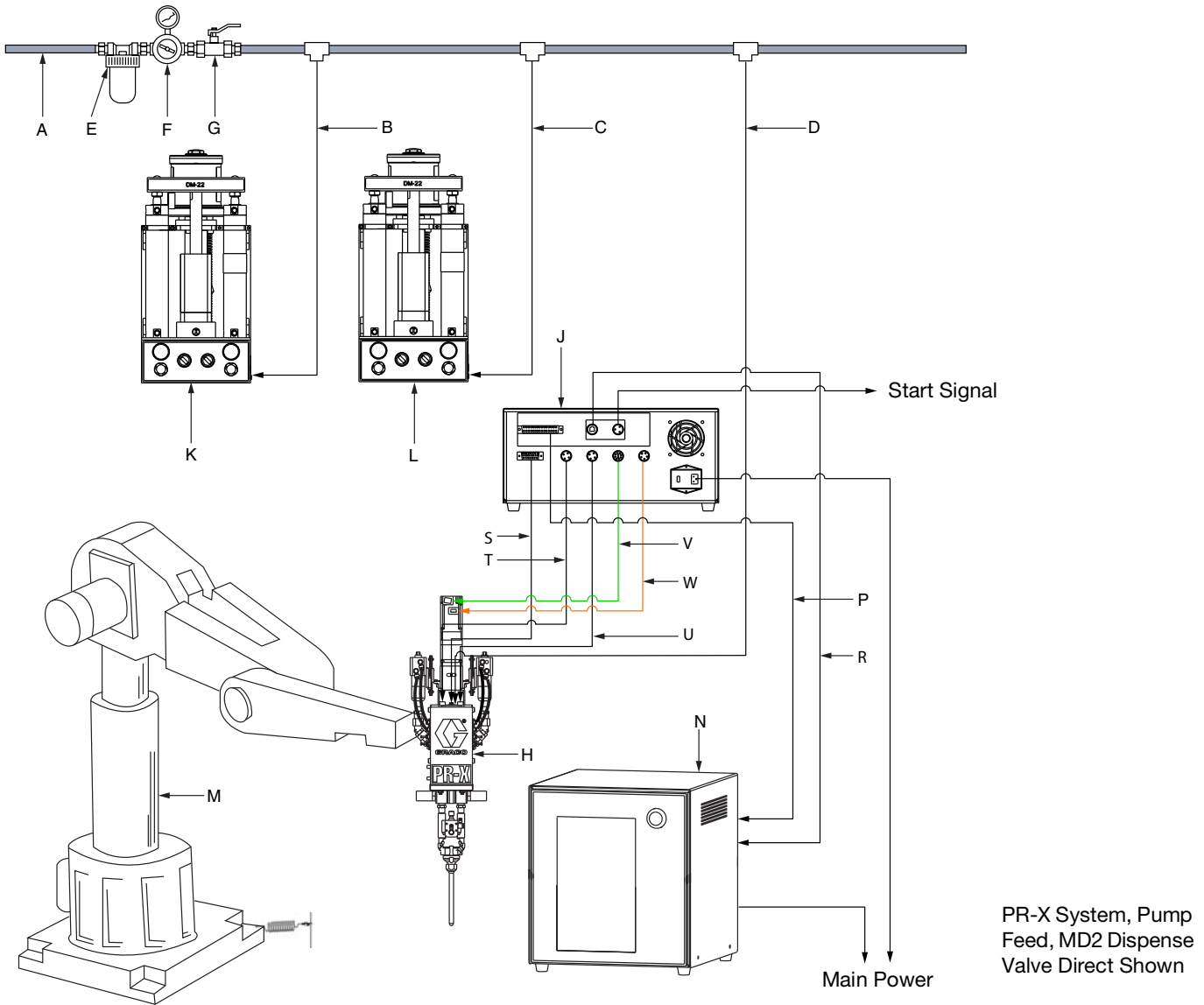

FIG. 1: Typical Installation

Key:

- A Main Air Line
- B Air Line of Supply Pump System A
- C Air Line of Supply Pump System B
- D PR-X System Air Line
- E Air Filter ⁽¹⁾
- F Pressure Regulator Valve ⁽¹⁾
- G Bleed-type Master Air Valve ⁽¹⁾
- H PR-X Metering Unit
- J PR-X Control Unit
- K Supply Pump System A
- L Supply Pump System B
- M Customer Robot
- N Customer Control Box
- P I/O Communication Cable (37 pin, T type)
- R Profinet Communication Cable (RJ45)
- S Junction Box Cable
- T Pressure Sensor A Cable
- U Pressure Sensor B Cable
- V Servo Motor Encoder Cable
- W Servo Motor Power Cable

⁽¹⁾ Required, but not supplied

PR-X System, Pump Feed, MD2 Dispense Valve Direct Shown

Component Identification

PR-X Metering Unit, Pump Feed

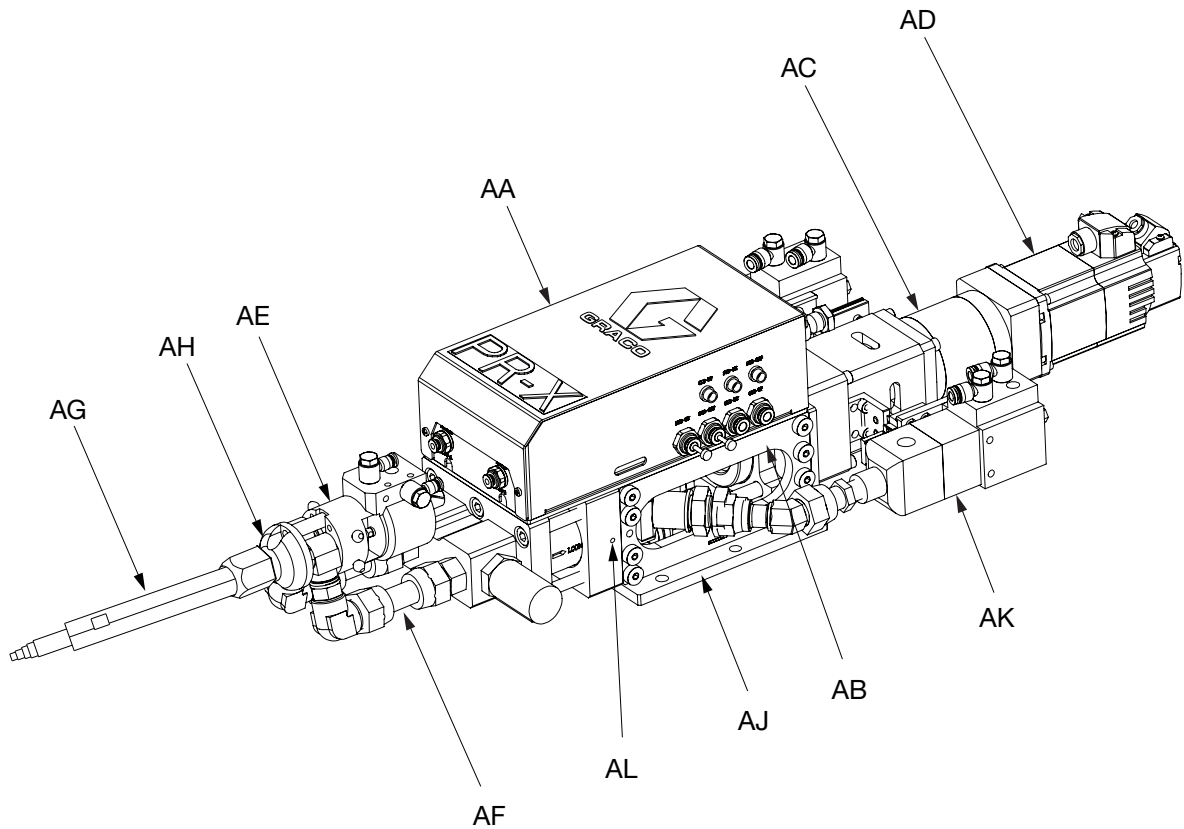

FIG. 2: PR-X Metering Unit, Pump Feed

Key:

- AA Junction Box Assembly
- AB Fixed Ratio Base Frame Assembly
- AC Ball Screw Assembly
- AD PR-X Drive
- AE MD2 Dispense Valve
- AF Direct Connection
- AG Static Mixer Package
- AH Nose Piece
- AJ PR-X Bottom Plate
- AK Inlet Valve (1K Ultra-Lite Valve)
- AL Leaking Hole

PR-X Control Unit

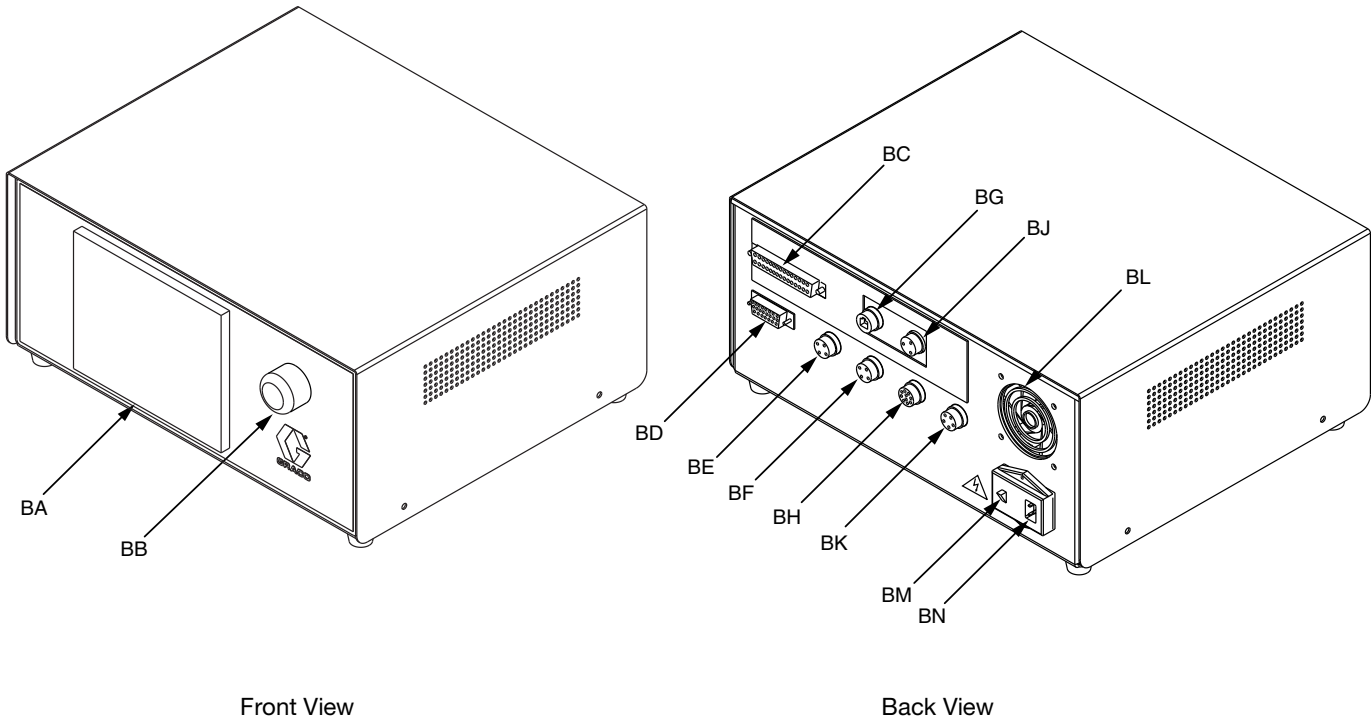

FIG. 3: PR-X Control Unit

Key:



- BA Human Machine Interface (HMI) Display
- BB Emergency Stop Switch
- BC Remote I/O Connection (37 pin, T type)
- BD Junction Box Connection
- BE Pressure Sensor A Connection
- BF Pressure Sensor B Connection
- BG Remote Ethernet Connection (RJ45)
- BH Servo Encoder Connection
- BJ Start Signal Connection
- BK Servo Motor Connection
- BL Cooling Fan
- BM Power Switch
- BN Power Connection

General Information

Different types of Static Mixer Package (AG) and Direct Connection (AF) are available from Graco. Make certain the Static Mixer Package (AG) and Direct Connection (AF) are adequately sized and pressure-rated to meet your system needs.

FIG. 2 and FIG. 3 are only a guide for identifying system components and for assisting in installation. Contact your Graco distributor or Graco China Customer Service for assistance in designing a system to suit your specific needs.

Installation

				
All electrical wiring must be done by a qualified electrician and comply with all local codes and regulations.				

Unpacking

1. Inspect the shipping container carefully for damage. Contact the carrier promptly if there is damage.
2. Open the box and inspect the contents carefully. There should not be any loose or damaged parts in the container.
3. Compare the packing slip against all the items in the box. Report any shortage or other inspection problems immediately.
4. Remove the PR-X system components from the container.

Locate and Install

1. The PR-X Metering Unit (H) can be directly mounted on a Customer Robot (M) or remotely mounted on a motion table or table top. Verify the location has access to compressed air and AC power.
2. Place the PR-X Metering Unit (H) onto the designated location.
3. Attach the PR-X Bottom Plate (AJ) to the selected location by installing fasteners (not provided with the PR-X metering unit) through the four mounting holes. There are also two position pin holes. Refer to FIG. 4 for mounting hole dimensions.

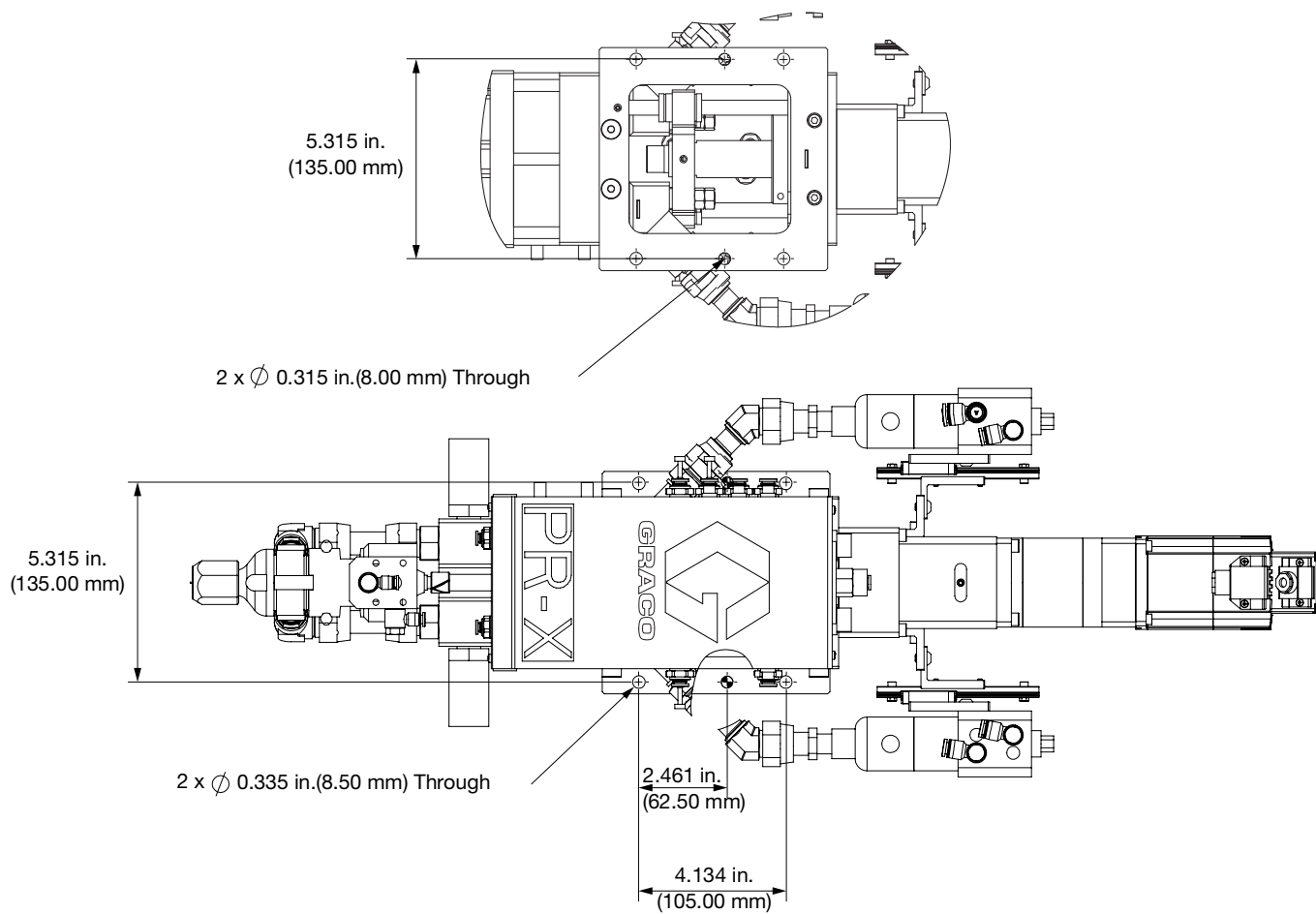





FIG. 4: Mounting Hole Dimensions for Installing the PR-X Metering Unit

Grounding

				
<p>The equipment must be grounded to reduce the risk of static sparking and electric shock. Electric or static sparking can cause fumes to ignite or explode. Improper grounding can cause electric shock. Grounding provides an escape wire for the electric current.</p>				

PR-X Metering Unit (H): grounded through the PR-X Bottom Plate (AJ). Use the supplied ground wire and clamp to ground the metal PR-X Bottom Plate (AJ) or Customer Robot (M) to a true earth ground.

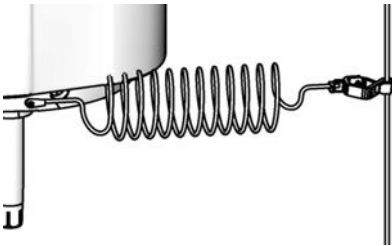

FIG. 5 Grounding

PR-X Control Unit (J): grounded through the power cord.

Air and fluid hoses: use only electrically conductive hoses with a maximum of 500 ft. (150 m) combined hose length to ensure grounding continuity. Check electrical resistance of hoses. If total resistance to ground exceeds 29 megohms, replace hose immediately.

Air compressor: follow manufacturer's recommendations.

MD2 Dispense Valve (AE): ground through connection to a properly grounded fluid hose and pump.

Fluid supply container: follow local code.

Solvent pails used when flushing: follow local code. Use only conductive metal pails, placed on a grounded surface. Do not place the pail on a nonconductive surface, such as paper or cardboard, which interrupts grounding continuity.

System Connections

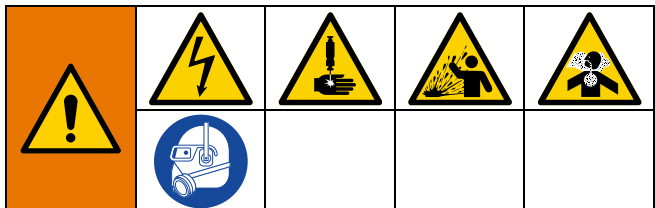

1. Connect the PR-X System Air Line (D) to the air inlet at the rear of Junction Box Assembly (AA). The maximum air pressure is 100 psi (0.7 MPa, 7 bar).

2. Connect the Material Supply Lines (M and N) to the corresponding material inlet at the top of Inlet Valve (AK).
3. Using the power cord provided, connect AC power (220 V, 50/60 Hz, single phase) to the Power Connection (BN) on the back of PR-X Control Unit (J).
4. Use cables to connect junction box, pressure sensor A and B, servo motor power and servo motor encoder from the PR-X Metering Unit (H) to PR-X Control Unit (J).

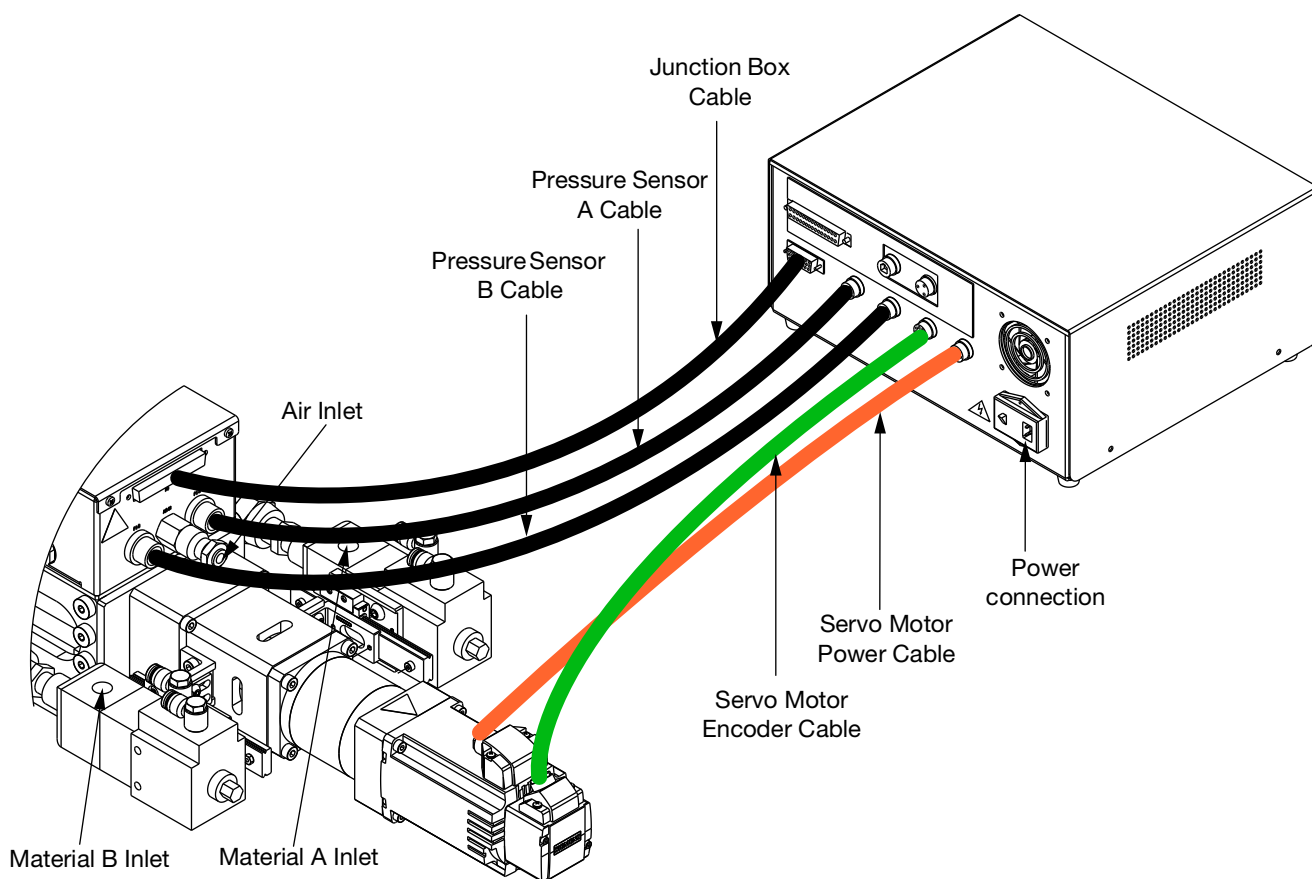

FIG. 6: Cable Connections - Pump Feed Version

Flush Before Using Equipment

The equipment was tested with lightweight oil, which is left in the fluid passages to protect parts. To avoid contaminating your fluid with oil, flush the equipment with a compatible solvent before using the equipment. Follow **Flush the Equipment** on page 42.

HMI Display Operation and Identification

Screen Navigation Diagrams

NOTE: 'Automatic Screen 1' is the start screen after 'Start' is selected in the 'Start Center' screen.

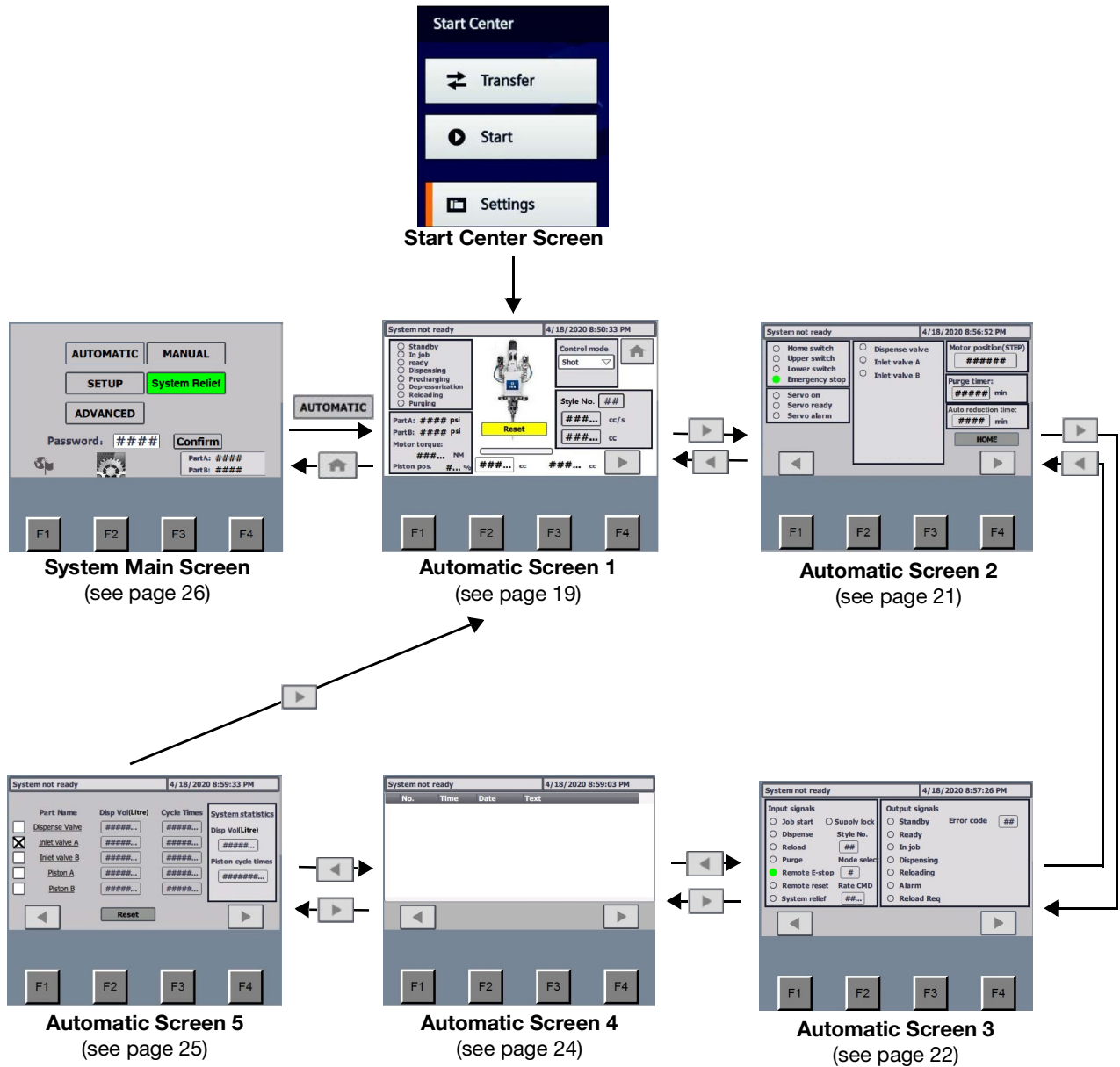

Continued

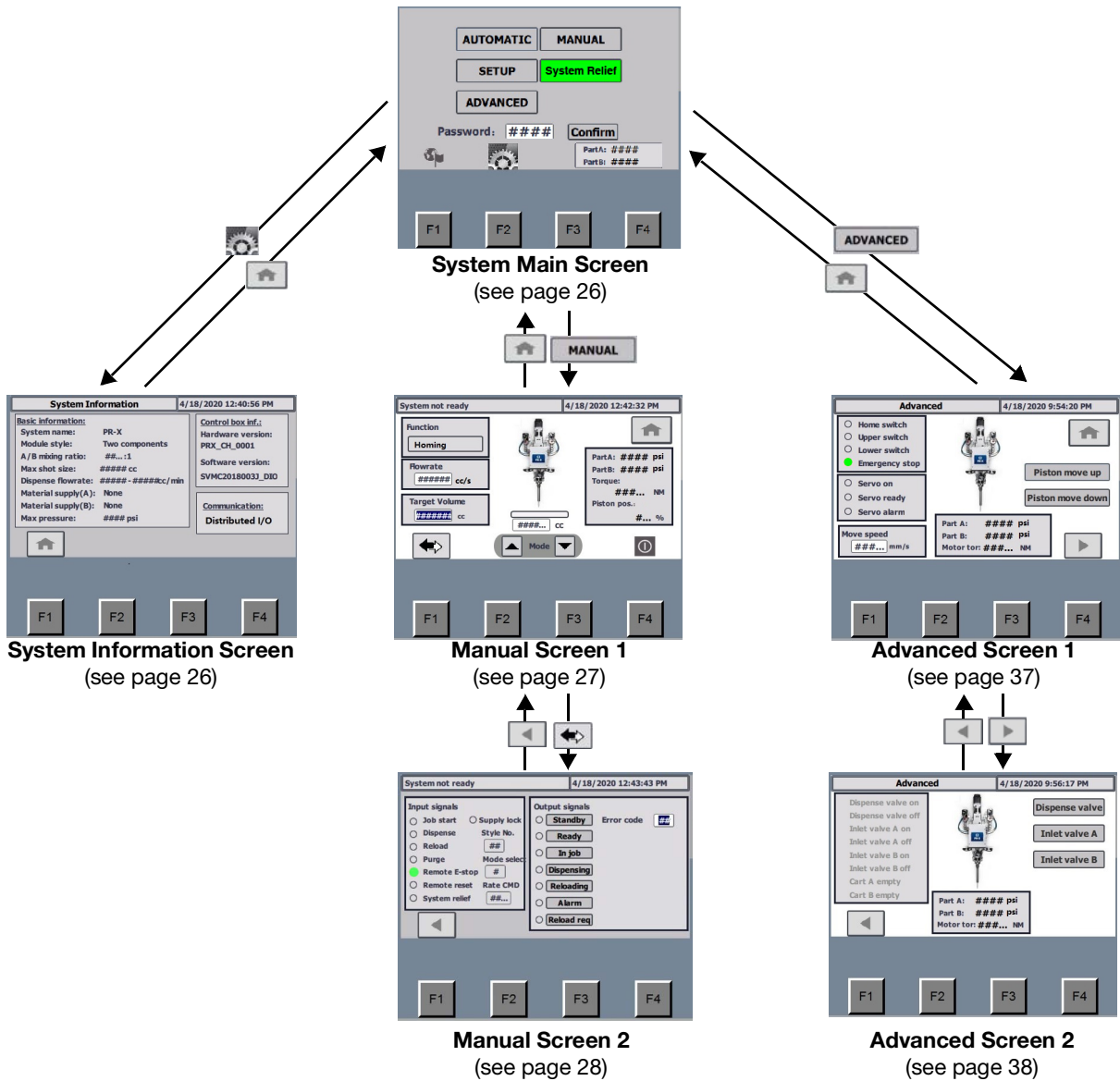

Continued

Note: Press the  button to display the System Main Screen on each Setup Screen.

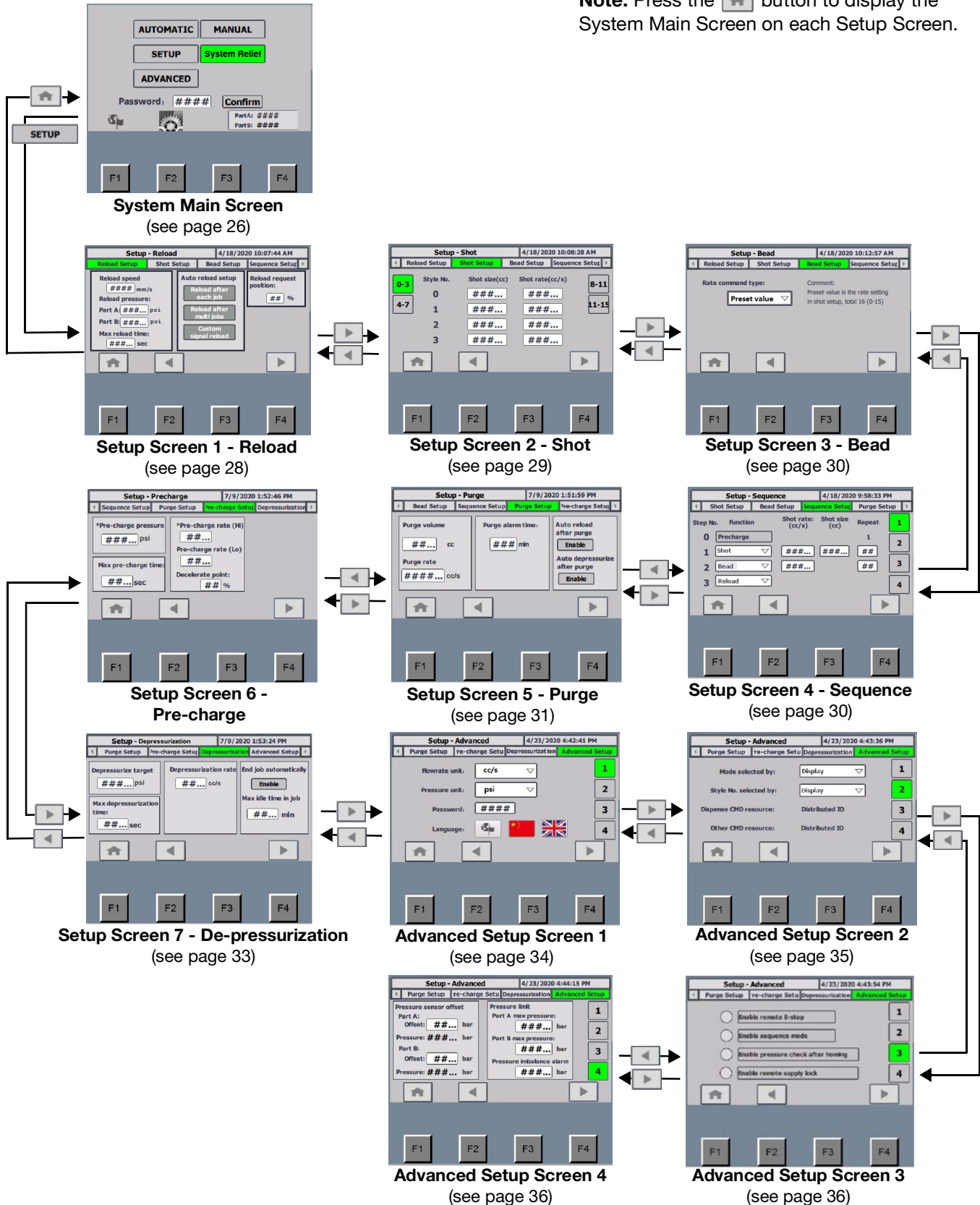

Automatic Screen 1

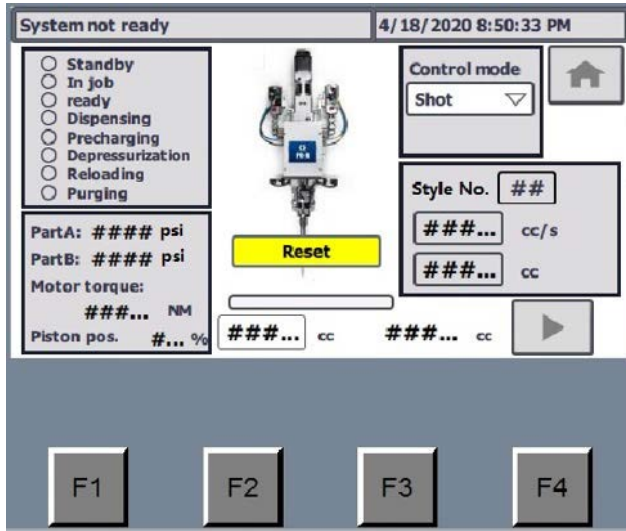
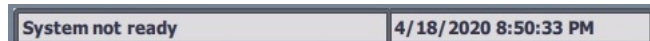

FIG. 7 Automatic Screen 1

After power up, the PLC program will be loaded automatically or by pressing 'Start' button at 'Start Center Screen'. Automatic Screen 1 will be shown on the display. Press 'F4' or select the button to display the Automatic Screen 2. Select the button to display the System Main Screen. This button can only be used when the system is in standby or has an alarm. When on the System Main Screen, the system will not work in automation mode.

The content and functions of this screen are as follows:

Information bar



- To illustrate the current status of equipment, such as Auto-Standby or Auto-Shot dispense.
- To show error information when an alarm is active.

System working status



- Standby: The system has checked the home position, but is not pre-charged.
- In Job: The job starts from pressure pre-charge and ends after depressurization. The system will record the dispense volume for each job. In shot or bead mode, 'job start' signal must be '1' during one job. In sequence mode, step 0 to step 15 will be considered one job.
- Ready: Pre-charge has been completed and the system is ready to dispense material.
- Dispensing: The system is dispensing material.
- Precharging: The system is pre-charging pressure for current job.
- Depressurization: The system is in the last step of the current job. In shot or bead mode, when 'job start' is from '1' to '0', system completes de-pressurization and finishes the current job.
- Reloading: The system is reloading material.
- Purging: The system is purging some material based on the preset flow rate and volume.

Current pressure, motor torque and piston position

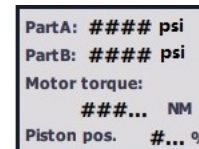

- Current pressure
 - Part A: Current pressure of A material.
 - Part B: Current pressure of B material.
- Motor torque: The torque of the drive motor is shown in NM. The motor torque range is -1.27 - 1.27 NM.
- Piston position: Display how much material is in the cylinders (0-100%). When the rod slider is at the home position, 'Piston position' will show 100%. When the slider moves to the 'empty' position, 'Piston position' will show 0%. The motor position range is 0-16800.

'Reset' Button



When the system sends out the alarm, select 'Reset' button to stop the alarm.

Progress bar and dispense volume

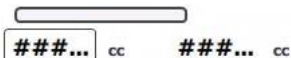

- Progress bar
 - Shot mode: The progress bar displays the completion of the current target.
 - Bead mode: the progress bar always displays 100%.
- Dispense volume: There are two dispense volume values. The left is the volume for current dispense, and the right is the current job's accumulative volume.

Control mode

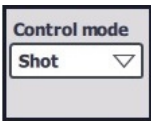

Automatic mode includes three control modes: shot mode, bead mode and sequence mode.

- Shot mode: Per the style selected, the system will dispense a shot at the volume of flow rate preset in the style selected.
- Bead mode: The system according to the selected style will complete the dispensing at the preset flow rate.
- Sequence mode: When the system works in automatic status, the Customer Control Box (N) can send 'dispense' signal to initiate the sequence. The working sequence can only be edited before dispense starts. (The sequence includes 16 steps maximum, and the operator can edit step 1 to 14, as step 0 and 15 are reserved respectively for pre-charge and depressurization).
 - When 'Enable Sequence Mode' option is not selected and the system is not dispensing, the operator may choose between 'Bead' or 'Shot' mode by using the touch screen or customer signal.
 - When 'Enable Sequence Mode' option is selected, control mode will be fixed as 'Sequence' mode. 'Bead' or 'Shot' mode will be inaccessible.

NOTE: 'Enable Sequence Mode' option is in screen 3 of Advanced setup. See **Advanced Setup Screen 3** on page 36.

System working information

This area will show information unique to each control mode.

- Shot mode



In Shot mode, the selected style number, target flow rate and target volume will be shown. Shot style can be selected by touch screen or customer signals. Preset styles include 16 styles, 0-15.

- Bead mode with preset value



In Bead mode with preset value, the selected style number and target flow rate will be shown. The process for style number selection is the same as in Shot mode.

- Bead mode with custom setting



In Bead mode with custom setting, 'Rate CMD' will be shown as voltage value and target flow rate will be shown. The flow rate will change based on rate command.

- Sequence mode

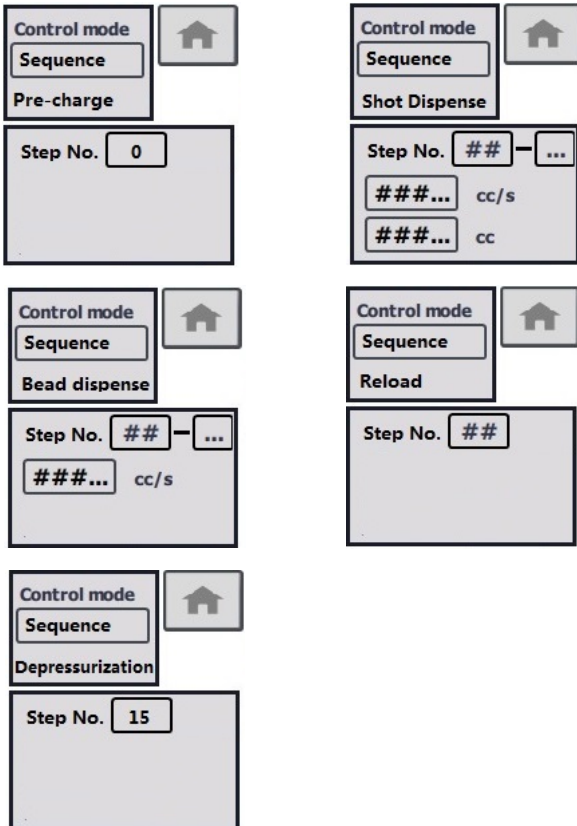

In Sequence mode, the step number, remaining repeat times, target flow rate and volume will be shown in different screens based on different step types. The operator can edit the step by using the touch screen prior to or following the current job. Once dispensing has begun, the 'Control mode' display will show the current step, including pre-charge, shot dispense, bead dispense, reload and depressurization.

Automatic Screen 2

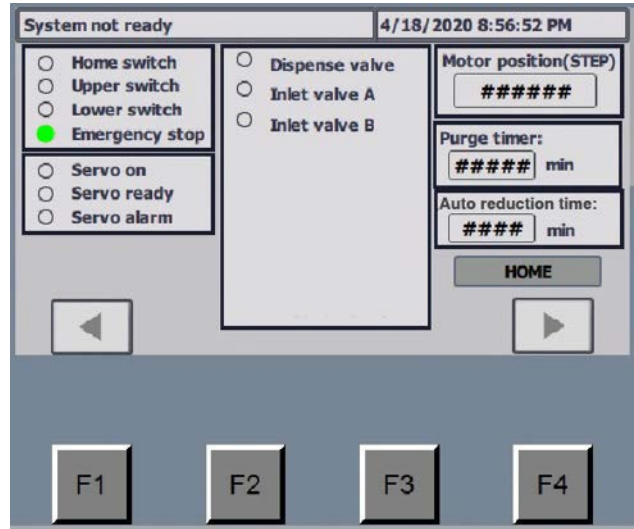
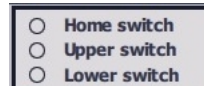

FIG. 8 Automatic Screen 2

On the Automatic Screen 2, press 'F1' or select the button to display the Automatic Screen 1. Press 'F4' or select the button to display the Automatic Screen 3.

The content and functions of this screen are as follows:

Sensors status



To show the 3 slider position sensors.

Emergency stop status

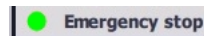

- Red circle: E-stop button is pushed in.
- Green circle: E-stop button is released.

Servo motor signals

<input type="radio"/> Servo on
<input type="radio"/> Servo ready
<input type="radio"/> Servo alarm

- Servo ON: This signal will be shown as green after system start.
- Servo ready: Motor can be used or is working without problem.
- Servo alarm: Something is wrong with the motor. Operator should push the reset button or send a remote reset signal. If reset does not work, the PR-X control unit needs to be restarted.

Motor position

Motor position(STEP)
#####

This display shows the number of motor steps. Each revolution of motor is 150 steps.

Purge time

Purge timer:
min

If the operator has set the 'Purge alarm time' on **Setup Screen 5 - Purge**, see page 31, the purge timer will be shown and the time displayed will count down. If the timer reaches ZERO, the system will send a 'purge request' signal and show 'purge request' in the information bar.

Auto reduction time

Auto reduction time:
min

If the operator enabled 'End job automatically' and set 'Max idle time in job' on **Setup Screen 7 - De-pressurization**, see page 33, the auto reduction time will be shown in box. If the timer times out, the system will automatically reduce the pressure and end the current job.

'HOME' button

HOME

This is the return to the Home point command. When the 'HOME' button is selected, the system must be inactive. Once the button to start the Home operation is selected, the button will blink until the piston returns to the Home point, and then the button will remain on until the next operation is started.

Automatic Screen 3

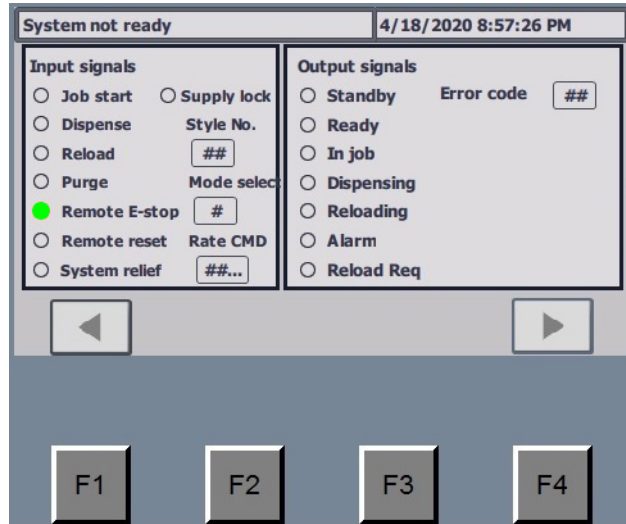

Fig. 9 Automatic Screen 3 (I/O Communication Mode)

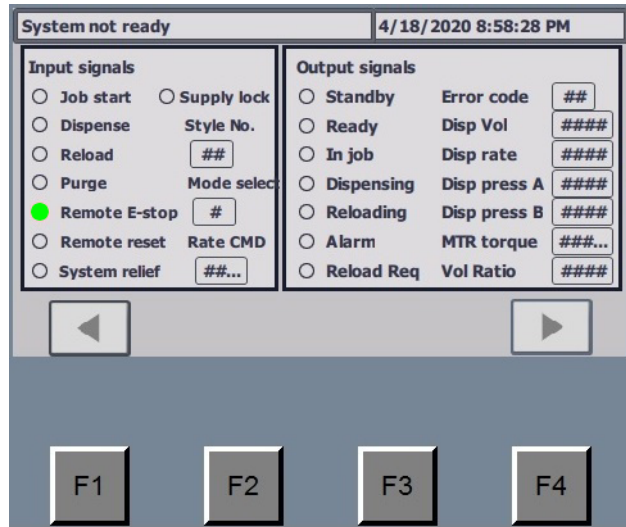
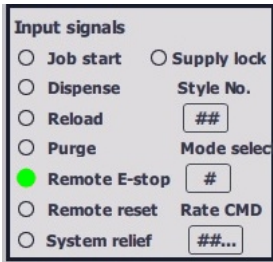

Fig. 10 Automatic Screen 3 (Profinet Communication Mode)

On the Automatic Screen 3, press 'F1' or select the ◀ button to display the Automatic Screen 2. Press 'F4' or select the ▶ button to display the Automatic Screen 4.

The content and functions of this screen are as follows:

Input signals status



The input signals display shows the current signal status from customer inputs.

- Rate CMD
 - If 'distributed IO' is selected as 'Other CMD Resource' on **Advanced Setup Screen 2**, see page 35, the input voltage signal will be shown as 0-10.0, where 0 means 0 voltage, 10.0 means 10 V.
 - If 'Gateway' is selected as 'Other CMD Resource' on **Advanced Setup Screen 2**, see page 35, the input data sent by Profinet will be shown as a value from 0 to 1000.

NOTE: The Gateway option is only included in the Profinet communication mode. Any PR-X system can be converted to use Profinet communication mode. Order SD card 18C277 and perform **Software Setup (For Profinet Communication Mode Only)** on page 43.

Output signals status



I/O communication mode



Profinet communication mode

The output signals display shows the current signal status from the PR-X control unit.

Error code	Port code	Error Type	Comment
0	00000	----	No Error
1	00001	Error	Estop
2	00010	Error	Lowest limit has been reached
3	00011	Error	Highest limit has been reached
4	00100	Error	Pre-charge time out
5	00101	Error	Pressure relief time out
6	00110	Error	Reload time out
7	00111	Error	Servo fault
8	01000	Error	Part A Supplier is in low level
9	01001	Error	Part B Supplier is in low level
10	01010	Error	Part A pressure exceeds system limit
11	01011	Error	Part B pressure exceeds system limit
12	01100	Error	Part A/B pressure is not balanced
13	01101	Error	Servo unit lost power
14	01110	Error	Inlet valve A does not turn on in time
15	01111	Error	Inlet valve B does not turn on in time
16	10000	Error	Dispense valve does not turn on in time
17	10001	Error	Inlet valve A does not turn off in time
18	10010	Error	Inlet valve B does not turn off in time
19	10011	Error	Dispense valve does not turn off in time
20	10100	Error	Pressure relief fault
21	10101	Error	Pre-charge fault
22	10110	Error	Homing fault
23	10111	Error	Motor torque is over limit
24	11000	Error	Motor peak torque is over limit
25	11001	Deviation	Illegal setting
26	11010	Deviation	Illegal command
27	11011	Deviation	Home is lost
28	11100	Deviation	Reload is requested (System is in job) or metering tube pump is empty (System is not in job)
29	11101	Deviation	Purge is requested
30	11110	Deviation	Automatic relief after idle
31	11111	Deviation	In system relieving

NOTE: The information below is exclusive to the Profinet communication mode.

- Disp vol: Dispense volume during current shot. The value from the PR-X control unit is an integer and must be multiplied by 0.01 to calculate the requested volume. The unit is cc.
- Disp rate: Dispense flow rate. The value from the PR-X control unit is an integer and must be multiplied by 0.001 to calculate the requested volume. The unit is cc/s.
- Disp press A: Current working pressure value of part A. The value from the PR-X control unit is an integer and the unit is psi.
- Disp press B: Current working pressure value of part B. The value from the PR-X control unit is an integer and the unit is psi.
- MTR torque: Current driver motor working torque. The value is an integer and must be multiplied by 0.001 to calculate the requested volume. The unit is NM.
- Vol ratio: Current dispense mixing ratio. The value is an integer and must be multiplied by 0.01 to calculate the requested volume.

Automatic Screen 4

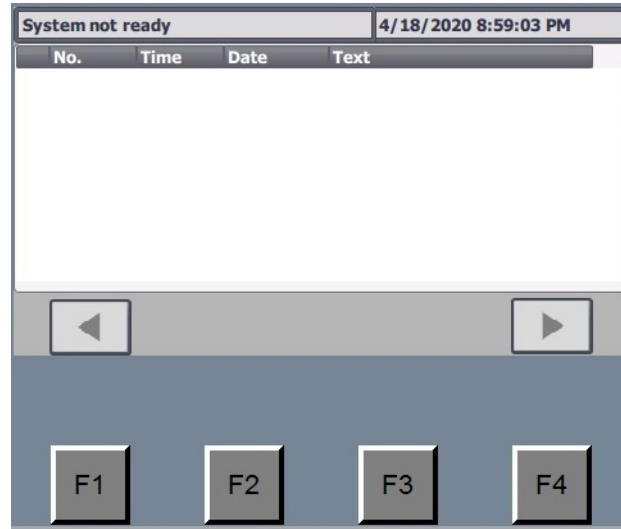



FIG. 11 Automatic Screen 4

On the Automatic Screen 4, press 'F1' or select the  button to display the Automatic Screen 3. Press 'F4' or select the  button to display the Automatic Screen 5.

This screen shows the error history. It will record the error number, time, date and explanation text for the last 50 system errors.

Automatic Screen 5

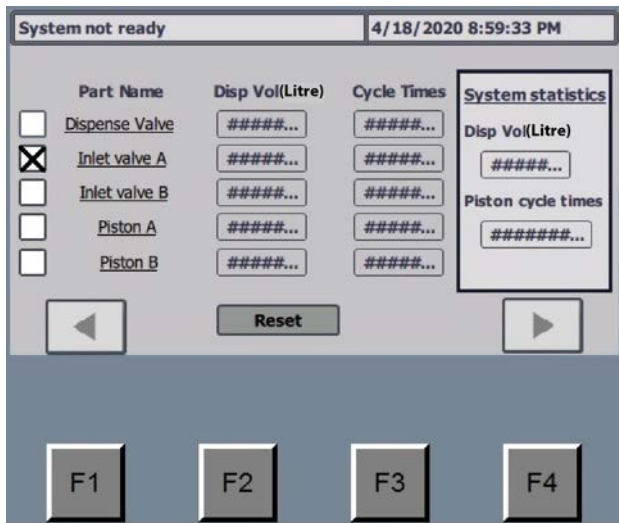

FIG. 12 Automatic Screen 5

On the Automatic Screen 5, press 'F1' or select the button to display the Automatic Screen 4. Press 'F4' or select the button to return to the Automatic Screen 1.

The content and functions of this screen are as follows:

Select box



After one or several selection boxes are selected, the 'Reset' button will appear. The operator can clear the selected record and restart data recording.

Workload record

Part Name	Disp Vol(Litre)	Cycle Times
Dispense Valve	#####...	#####...
Inlet valve A	#####...	#####...
Inlet valve B	#####...	#####...
Piston A	#####...	#####...
Piston B	#####...	#####...

To record the workload of important parts. This data can be reset.

System statistics



This section displays the whole system workload record. This data cannot be reset.

System Main Screen

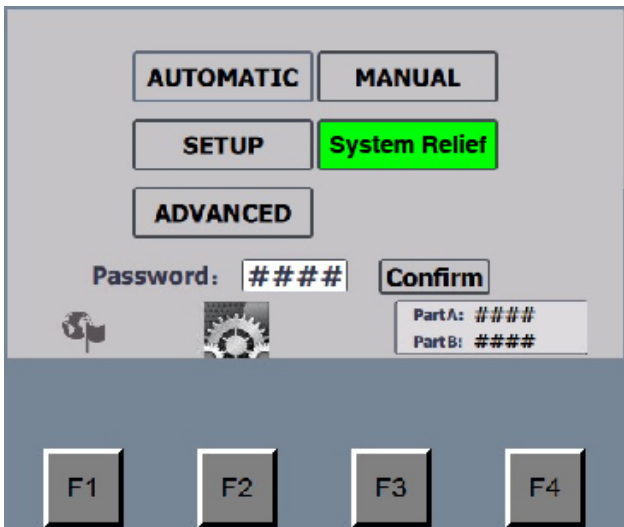





FIG. 13 System Main Screen

On the Automatic Screen 1, press  button to display the System Main Screen. On this screen, the operator can switch the system to Automatic mode, Manual mode, Setup mode, System Relief function or Advanced Mode.

Press 'F1' or select the  button to display language options (Chinese or English). Press 'F2' or select the  button to display the System Information Screen.

If the operator has already set up password protection on **Advanced Setup Screen 1**, see page 34, the password must be entered to visit the Setup Screens.

To open the Advanced mode, the operator must enter the password **1492**. The Advanced option won't show until the password has been entered.

Select 'System Relief' button, the system will identify whether the inlet valve (AK) is closed. If the Inlet Valve (AK) is opened, it will be closed. Then the MD2 Dispense Valve (AE) will be opened. The whole system pressure is relieved. When the 'System Relief' is selected, the real-time pressure of part A and part B will be displayed on the System Main Screen.

System Information Screen

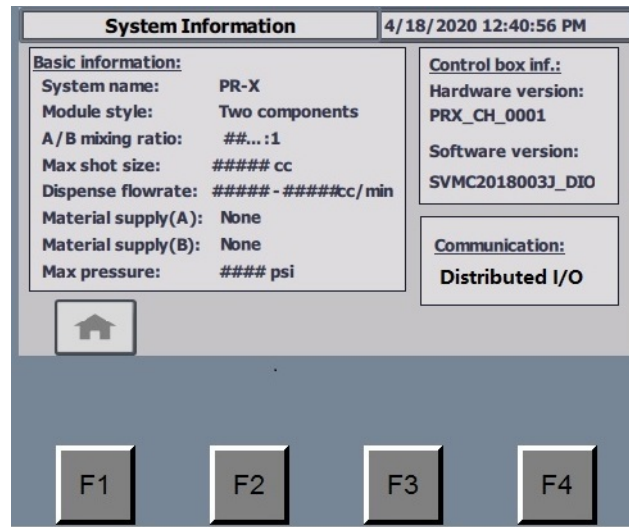



FIG. 14 System Information Screen

General system information can be found in this screen. Press 'F1' or select the  button to return to the System Main Screen.

Manual Screen 1

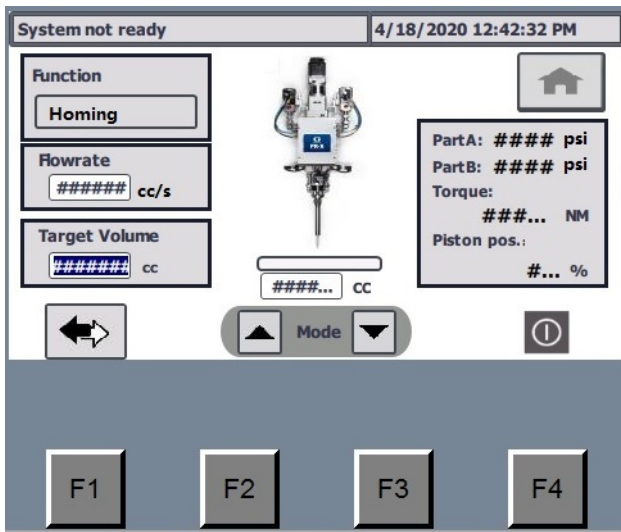

FIG. 15 Manual Screen 1

On the Manual Screen, press 'F1' or select the button to display the Manual Screen 2. Press 'F4' or select the button to execute the current operation selected from 'Function mode' dropdown

list . Select the button to display the System Main Screen. This button can only be selected when the system is in standby or alarm mode. When the operator has entered the System Main Screen, the system will not work in Automation mode.

The content and functions of this screen are as follows:

Function mode operation select

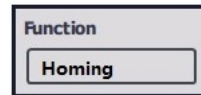

Function includes 7 operations: Homing, Pre-charge, Shot dispense, Bead dispense, Reload, Depressurization and Purge.

Flowrate and target volume



Parameter setting of flow rate and target volume. The flowrate range is 0.016-2.880 cc/s. The target volume range is 0-53.76 cc.

Progress bar and actual dispense volume



- Shot mode: Displays the progress bar showing the completion of the current target and the actual dispensing volume.
- Bead mode: The progress bar always displays 100%. The actual dispensing volume will increase during bead dispensing and the target volume will display a value consistent with the actual volume.

Current pressure, motor torque and piston position

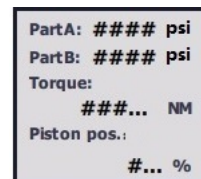

- Current pressure
 - Part A: Current pressure of A material.
 - Part B: Current pressure of B material.
- Motor torque: The torque of the drive motor is shown in NM. The motor torque range is -1.27 - 1.27 NM.
- Piston position: Displays how much material is in the cylinders (0-100%). When the rod slider is at the home position, 'Piston position' will show 100%. When the slider moves to the 'empty' position, 'Piston position' will show 0%. The motor position range is 0-16800.

Manual Screen 2

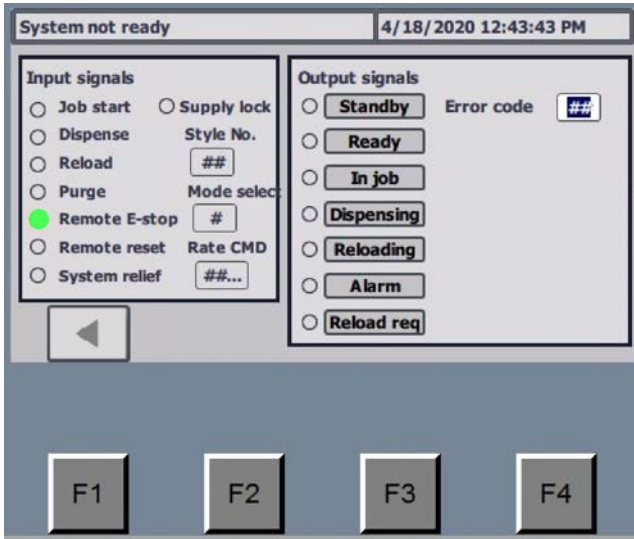

FIG. 16 Manual Screen 2 (I/O Communication Mode)

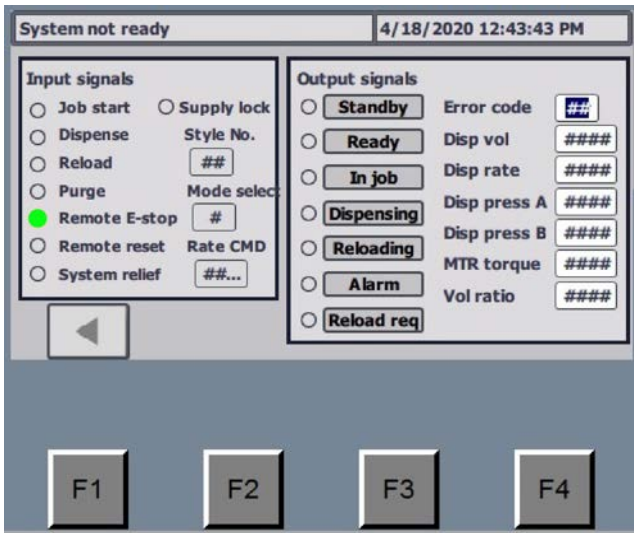



FIG. 17 Manual Screen 2 (Profinet Communication Mode)

On the Manual Screen 2, press 'F1' or select the  button to display the Manual Screen 1.

The Manual Screen 2 is used to check the signal exchange only.

Setup Screen

Setup Screen 1 - Reload

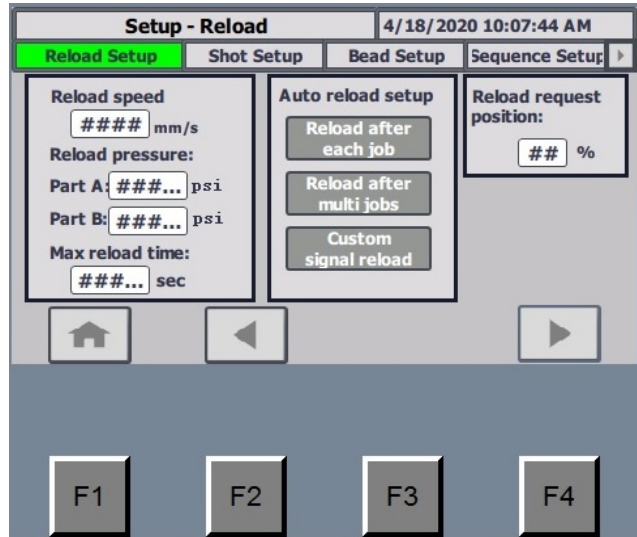



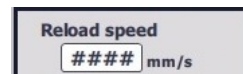

FIG. 18 Reload Setup Screen

On the Reload Setup Screen, press 'F1' or select the  button to display the System Main Screen. Press 'F2' or select the  button to return to the previous screen. Press 'F4' or select the  button to continue to the next screen.

The content and functions of this screen are as follows:

Reload speed setup



Set both the reloading speed and 'Home' operations speed. The reload speed range is 0.01-1.5 mm/s.

Reload pressure setup

Reload pressure:
 Part A: ###... psi
 Part B: ###... psi

Set the reload pressure for part A and B. During reloading, after piston returns to home position, the system will keep the Inlet Valve (AK) open until part A and B pressure has exceeded the preset reload pressure. The reload pressure range is 0.1200 psi.

Maximum reload time

Max reload time:
 ###... sec

Set reload time limit. If the reload process exceeds the time limit, the system will send out an alarm as a reload time out.

Reload type setup

Auto reload setup

- Reload after each job
- Reload after multi jobs
- Custom signal reload

- Reload after each job: The system automatically reloads after each job.
- Reload after multi jobs: The system automatically reloads after multiple jobs.
- Custom signal reload: The system will not reload automatically. The system will reload only when prompted by external signal.

Reload request position

Reload request position:
 ## %

- When the material in the supply pump system is less than the percentage set here, the system will send out an alarm, but the system can still work.
- If Reload after each job or Reload after multi jobs is selected, and the material in the supply pump system is less than the percentage set here, the system automatically reloads after each job or multiple jobs.

Setup Screen 2 - Shot

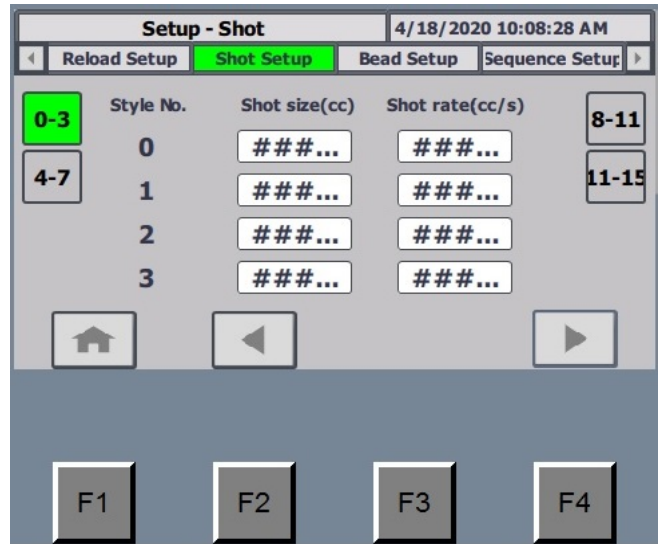

FIG. 19 Shot Setup Screen

On the Shot Setup Screen, press 'F1' or select the button to display the System Main Screen. Press 'F2' or select the button to return to the previous screen. Press 'F4' or select the button to continue to the next screen.

This screen includes 4 pages to set flowrate and target volume for 16 styles.

Setup Screen 3 - Bead

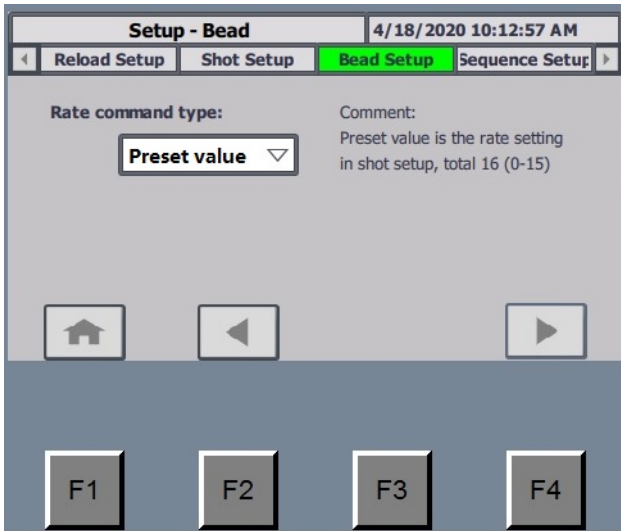

FIG. 20 Bead Setup Screen (Preset value)

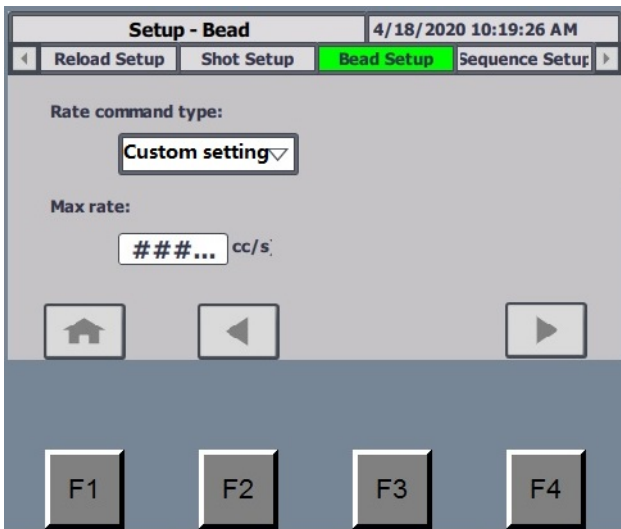

FIG. 21 Bead Setup Screen (Custom setting)

On the Bead Setup Screen, press 'F1' or select the button to display the System Main Screen. Press 'F2' or select the button to return to the previous screen. Press 'F4' or select the button to continue to the next screen.

There are two Rate command types:

- Preset value: The flow rate is defined on **Setup Screen 2 - Shot**, see page 29. 'Shot bit 0-3' signals or style numbers are used to select flow rate.
- Custom setting: The operator should set 'Max Rate' first. The Operator can use 0-10 V signal to control flow rate.

Setup Screen 4 - Sequence

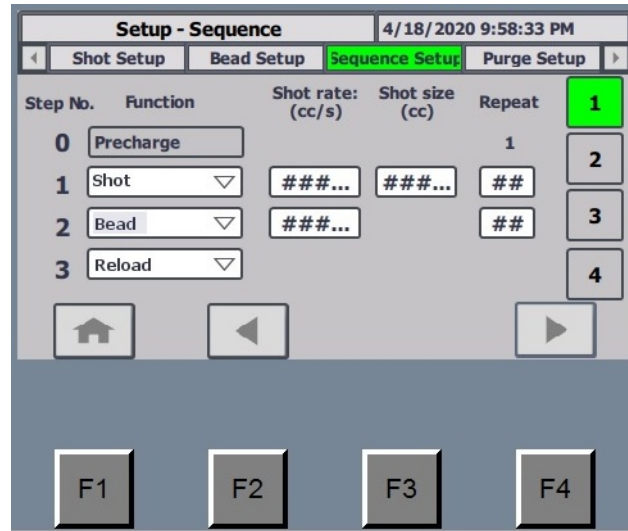

FIG. 22 Sequence Setup Screen

On the Sequence Setup Screen, press 'F1' or select the button to display the System Main Screen. Press 'F2' or select the button to return to the previous screen. Press 'F4' or select the button to continue to the next screen.

Sequence includes 16 steps maximum. Step 0 and step 15 are used to start job (Pre-charge) and end job (Depressurization). Operator can select functions including shot, bead, reload and none. If the shot or bead function is selected, repeat time can be set (1-99).

Setup Screen 5 - Purge

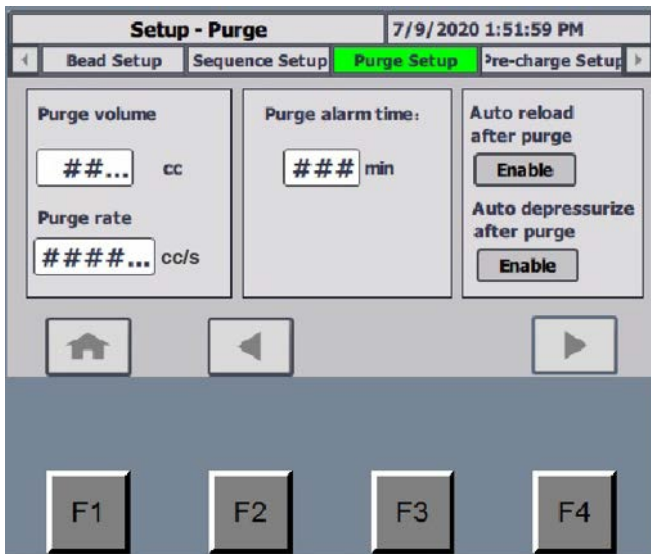
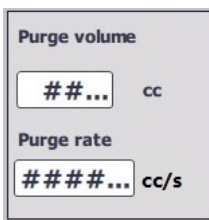

FIG. 23 Purge Setup Screen

On the Purge Setup Screen, press 'F1' or select the button to display the System Main Screen. Press 'F2' or select the button to return to the previous screen. Press 'F4' or select the button to continue to the next screen.

The content and functions of this screen are as follows:

Purge volume and rate setup



- Purge volume: Set the target purge volume.
- Purge rate: Set the purge flowrate.

Purge alarm time

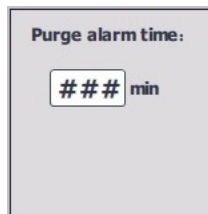

Set the purge request timer. When the equipment doesn't dispense, the PR-X control unit will start the countdown for the time chosen by the operator. When the time is 0, the system will send out the purge alarm signal.

Purge type setup

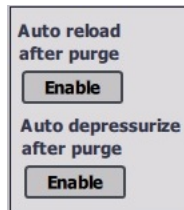

- Auto reload after purge button: When enabled, the system automatically reloads after purge is completed.
- Auto depressurize after purge button: When enabled, the system automatically performs depressurization after purge is completed.

Setup Screen 6 - Pre-charge

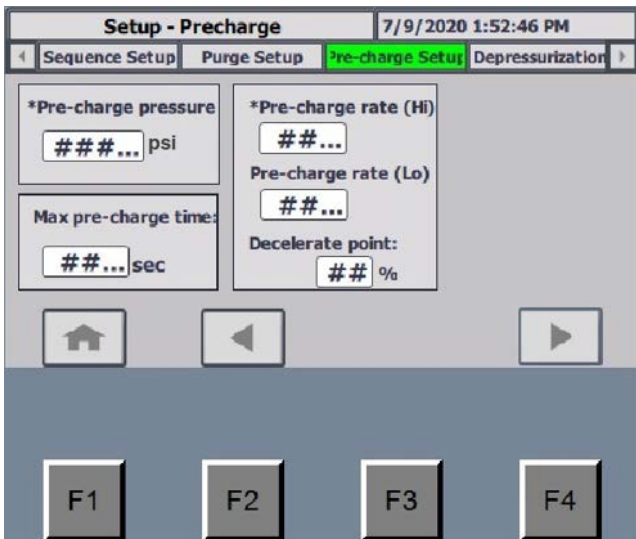
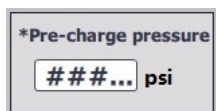

FIG. 24 Pre-charge Setup Screen

On the Pre-charge Setup Screen, press 'F1' or select the button to display the System Main Screen. Press 'F2' or select the button to return to the previous screen. Press 'F4' or select the button to continue to the next screen.

The content and functions of this screen are as follows:

Pre-charge pressure



The operator may set the pre-charge pressure in psi.

Maximum pre-charge time limit

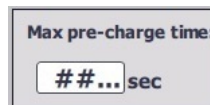

The operator may set the time in seconds the system may spend pre-charging. If pre-charging exceeds the set time, the system will activate the alarm to alert the operator the limit has been reached.

Pre-charge speed

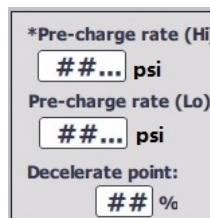



The operator may set two separate pre-charge rates. The system will pre-charge at the set 'Hi' speed until reaching the decelerate point. The decelerate point is the target pressure at which the system will switch from the "Hi" to the "Lo" pre-charge rate. Enter the decelerate point as a percentage of the Pre-charge pressure. For example, if the pre-charge pressure is 500 psi and the decelerate point is 75%, the system will switch to the 'Lo' speed once pressure has reached 375 psi. The system will then continue pre-charging at the set 'Lo' speed until system confirms the pressure has exceeded the set target pressure.

Setup Screen 7 - De-pressurization

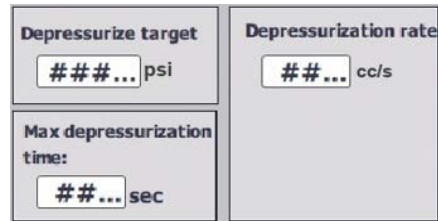

FIG. 25 De-pressurization Setup Screen

On the De-pressurization Setup Screen, press 'F1' or select the  button to display the System Main Screen. Press 'F2' or select the  button to return to the previous screen. Press 'F4' or select the  button to continue to the next screen.

The content and functions of this screen are as follows:

De-pressurization setup



- Depressurization target: The operator may set the depressurization target. The system will reduce the pressure to the target value automatically when the job is finished.

NOTE: Set different depressurization targets according to different materials. For detailed information, please contact your Graco distributor.

- Max depressurization time: The operator may set a maximum time in seconds for the system to perform depressurization. If depressurization function exceeds the set time, the system alarm will be activated.
- Depressurization rate: The operator may input a value here to set the piston speed during depressurization.

End job automatically



After this option is enabled, the operator must set the maximum idle time for the system while performing a job. After the set period passes without any operation, the depressurization program will be automatically executed and the current job ended.



Advanced Setup Screen

Advanced Setup Screen 1



FIG. 26 Advanced Setup Screen - 1

On the Advanced Setup Screen 1, press 'F1' or select the  button to display the System Main Screen.

Press 'F2' or select the  button to return to the previous screen. Press 'F4' or select the  button to continue to the next screen.

The content and functions of this screen are as follows:

Flowrate unit

The operator may select either cc/minute or cc/second from the dropdown list to customize the units used for flowrate setup.

Pressure unit

The operator may select psi, bar or MPa from the dropdown list to customize the units used for pressure setup.

Password

If this function is selected, a 4-digit number should be set. After the 4-digit number is set, the operator must be prompted to input the password before navigating to any of the setup screens.

Language

The operator may select either Chinese (by selecting the Chinese flag) or English (by selecting British flag) to change the language used on the system's user interface.

Advanced Setup Screen 2

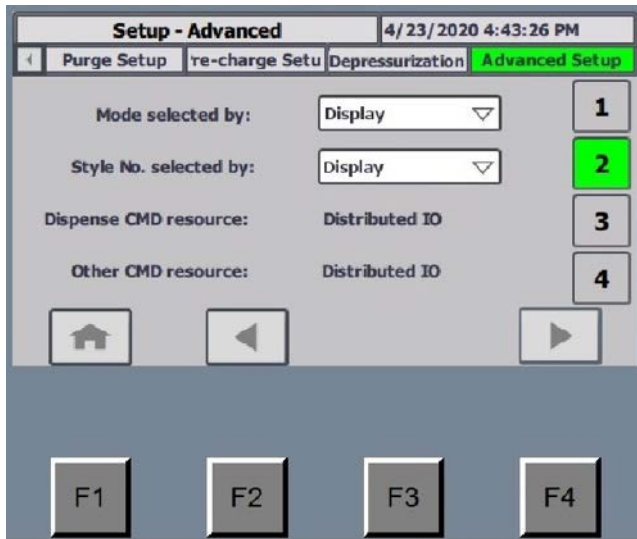

FIG. 27 Advanced Setup Screen - 2 (I/O Communication Mode)

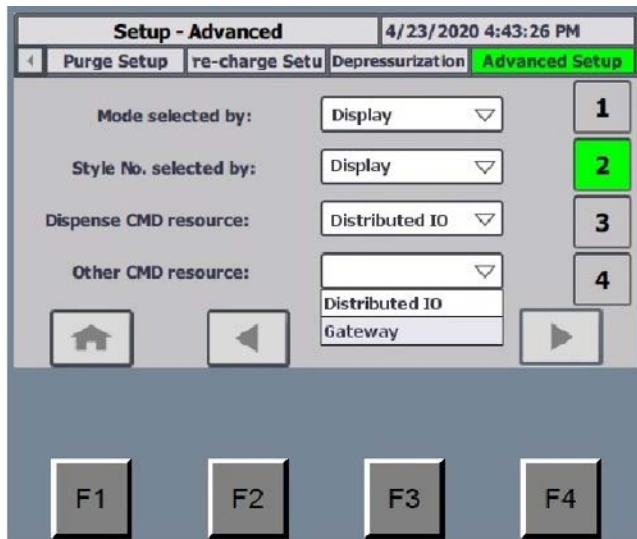





FIG. 28 Advanced Setup Screen - 2 (Profinet Communication Mode)

On the Advanced Setup Screen 2, press 'F1' or select the  button to display the System Main Screen. Press 'F2' or select the  button to return to the previous screen. Press 'F4' or select the  button to continue to the next screen.

The content and functions of this screen are as follows:

Mode selected by

Options for mode selection input include Display, Distributed IO or Gateway.

- If 'Distributed IO' or 'Gateway' is selected, in Automatic mode, the shot or bead working mode (Sequence mode will be inaccessible) must be controlled by customer signals. The operator will not be able to change working mode using the touch screen.
- If 'Display' is selected, working mode will include Shot, Bead and Sequence mode. The operator will be able to change working mode using the touch screen.

Style No. selected by

The operator may choose whether the style number may be changed by Display, Distributed IO or Gateway.

Dispense CMD resource

The operator may choose whether the Dispense Command (CMD) resource comes from Distributed I/O communication or Gateway (Profinet) communication. Display option is unavailable.

Other CMD resource

The operator may choose whether the Other Command (CMD) Resource comes from Distributed I/O communication or Gateway (Profinet) communication. Display option is unavailable.

Other command (CMD) includes job start, reload, purge start, remote reset.

NOTE: The Gateway option is only included in the Profinet communication mode. Any PR-X system can be converted to use Profinet communication mode. Order SD card 18C277 and perform **Software Setup (For Profinet Communication Mode Only)** on page 43.

Advanced Setup Screen 3

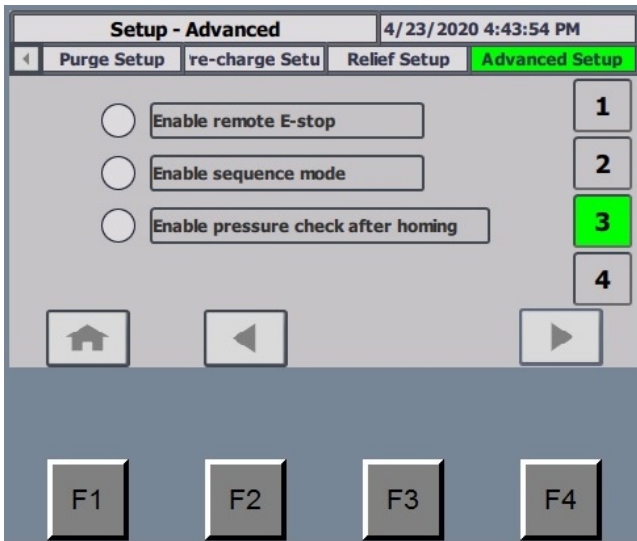

Fig. 29 Advanced Setup Screen - 3

On the Advanced Setup Screen 3, press 'F1' or select the button to display the System Main Screen. Press 'F2' or select the button to return to the previous screen. Press 'F4' or select the button to continue to the next screen.

The content and functions of this screen are as follows:

Enable remote E-stop

If this function is selected, the PR-X system can be shut down from an external signal. When the signal changes to a '0', the PR-X system will shut down. This function acts the same as the Emergency Stop Switch (BB) on the front of the PR-X control unit.

Enable sequence mode

If this function is selected, the PR-X system will run in sequence mode. In this mode, the operator can edit the working sequence (The sequence includes 16 steps maximum. The operator can edit step 1 to 14, as step 0 and 15 are tied to pre-charge and depressurization). When the system works in automatic status, the Customer Control Box (N) can send 'dispense' signal to start the sequence mode and then dispense step by step.

Enable pressure check after homing

If this function is selected, the system pressure will be checked when the piston is in the home position.

Advanced Setup Screen 4

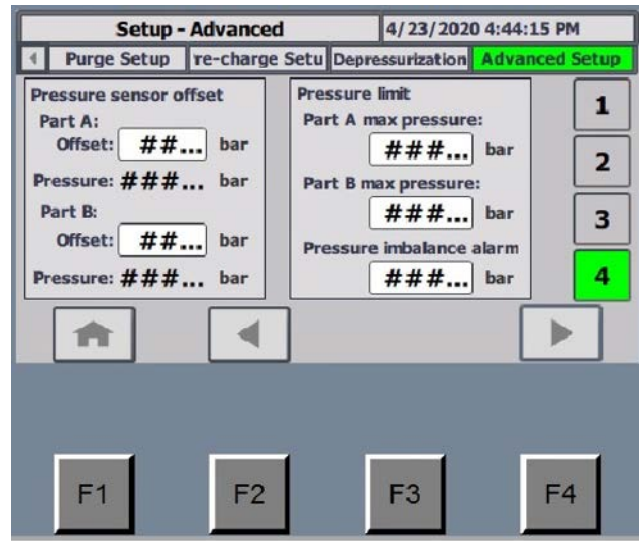
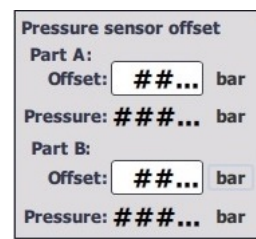

Fig. 30 Advanced Setup Screen - 4

On the Advanced Setup Screen 4, press 'F1' or select the button to display the System Main Screen. Press 'F2' or select the button to return to the previous screen. Press 'F4' or select the button to continue to the next screen.

The content and functions of this screen are as follows:

Pressure sensor offset



The operator may input values to adjust the pressure offset on the sensors. The pressure offset range is -100-100 psi.

Pressure limit

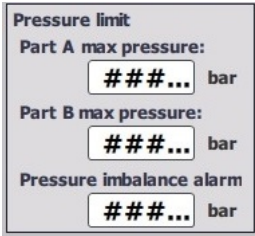

If the Part A or B pressure is higher than the preset max pressure, the system will activate the alarm and send the alarm signal to customer system.
 During dispensing, the system will check the difference between part A and B. If the pressure difference is higher than preset limit, the system will send the alarm signal and stop dispensing.

Advanced Screen 1

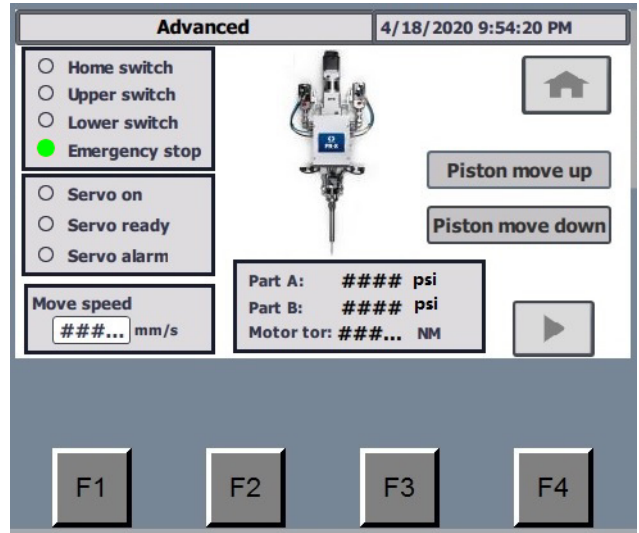

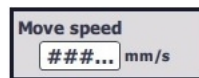

FIG. 31 Advanced Screen 1

On the Advanced Screen 1, press 'F4' or select the  button to display the Advanced Screen 2. Advanced screens 1 and 2 are dedicated to repairing and testing the system. After navigating to this screen, the logic relationship between the drive motor, reloading valves and dispense valves will be overrode and the operator may control each part individually. For this reason, only qualified personnel who have received equipment maintenance training should be authorized to navigate to this screen and perform system check.

The content and functions of this screen are as follows:

Move speed



This box is for setting the speed of the slide block.

Piston move up

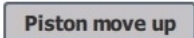

This button is for motor, slide block and piston tests. Jog control pistons and slide block move away from the outlet port.

Piston move down

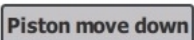

Jog control pistons and slide block move toward the outlet port.

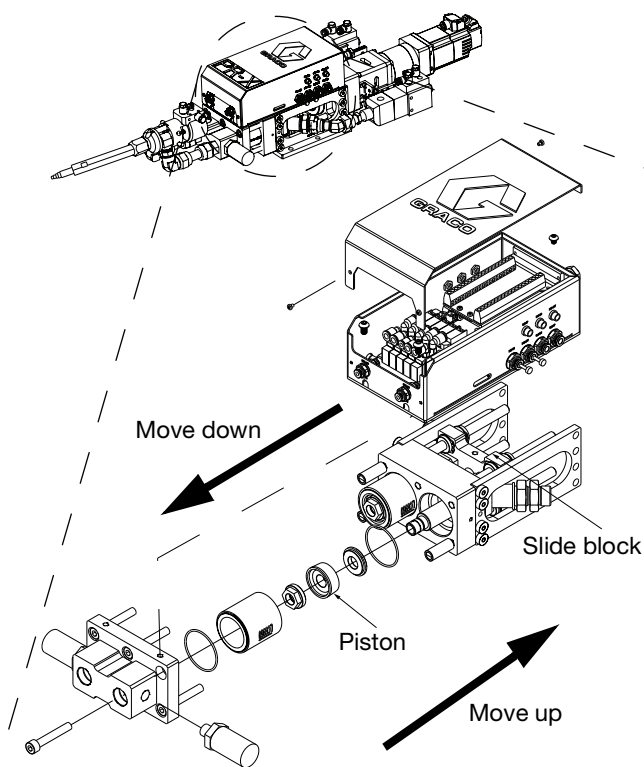

FIG. 32 Piston move up or down

Advanced Screen 2

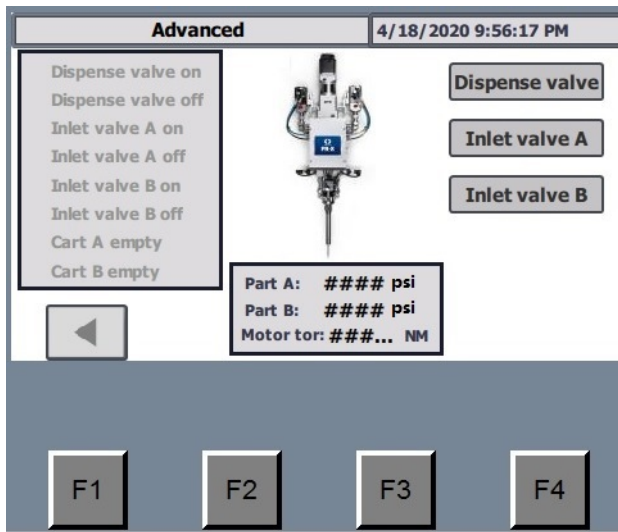
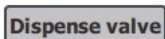

FIG. 33 Advanced Screen 2

On the Advanced Screen 2, press 'F1' or select the ◀ button to return to the Advanced Screen 1.

The content and functions of this screen are as follows:

Dispense valve



Selecting this button enables testing of the MD2 Dispense Valve (AE) by controlling the opening or closing of the valve. When the MD2 Dispense Valve (AE) is open, the button will be green; when the MD2 Dispense Valve (AE) is closed, the button will be gray.

Inlet valve A and inlet valve B



Selecting each of these buttons enables testing of inlet valve A and B (AK), respectively, by controlling the opening or closing of the valve. When the Inlet Valve (AK) is open, the button will be green; when the Inlet Valve (AK) is closed, the button will be gray.

Operation

Startup



1. Locate the Power Switch (BM) at the rear of the PR-X Control Unit (J) and turn the power on.
2. With the air line (C) connected to the PR-X Metering Unit (H), go to the Advanced Screen 2 of the PR-X Control Unit (J), then select 'Inlet valve A' and 'Inlet valve B' to turn on Inlet Valve A and B (AK).

NOTE: Very viscous, compressible materials may continue to leak after system is primed. Reduce flow rate as required to produce air-free dispensation. Very thin materials may require tilting the valve greater than 45 degrees and dispensing shots until material is air-free.

NOTE: Air entering the machine should be filtered.

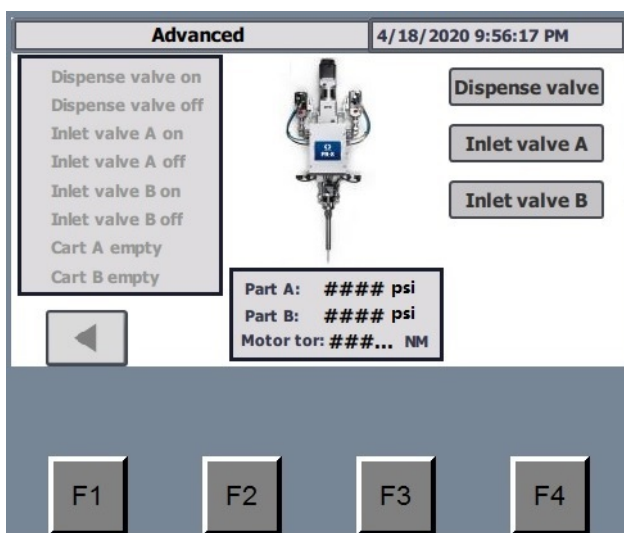

FIG. 34 Advanced Screen 2

3. Adjust the Pressure Regulating Valve (F) so the air pressure provided by the customer is at least 80 psi (0.6 MPa, 6 bar), and no higher than 100 psi (0.7 MPa, 7 bar).

NOTE: If needed, add the pressure relief valve to reduce pressure to 100 psi (0.7 MPa, 7 bar).

4. Perform **Prime the System** on page 40.
5. Perform the **Ratio Check Procedure** on page 41.
6. Install Static Mixer Package (AG).
7. Dispense several full stroke shots until the PR-X Metering Unit (H) is free of air and there is no leakage at the Nose Piece (AH) after shutoff.

Prime the System



1. Remove Static Mixer Package (AG) from the MD2 Dispense Valve (AE) (if installed) and place a waste container below it.
2. Pressurize the A and B Material Feed System (K and L); set the lower pressure to 20 psi (0.14 MPa, 1.4 bar).
3. Go to the Advanced Screen 1 of the PR-X Control Unit (J). Select 'Piston move up', the piston moves up until the sensor sends out the stop signal, then set the move speed to 0.2 cc/s.

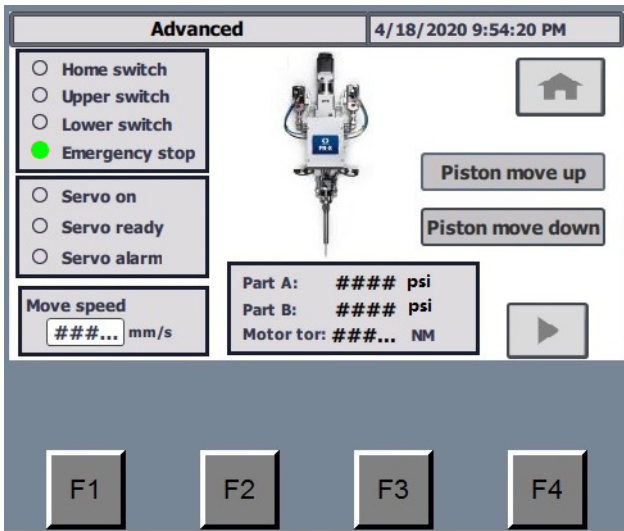

Fig. 35 Advanced Screen 1

4. Select 'Dispense valve', 'Inlet valve A' and 'Inlet valve B' to turn on MD2 Dispense Valve (AE) and Inlet Valve A and B (AK).

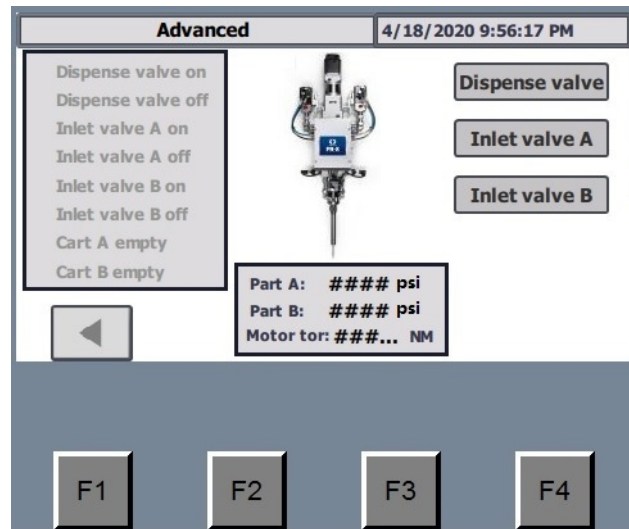

Fig. 36 Advanced Screen 2

5. When both sides of the system have a continuous and stable flow, select 'Dispense valve' again to turn off the MD2 Dispense Valve (AE).
6. Return to the Manual screen 1. Change the function to reload, then run the system.

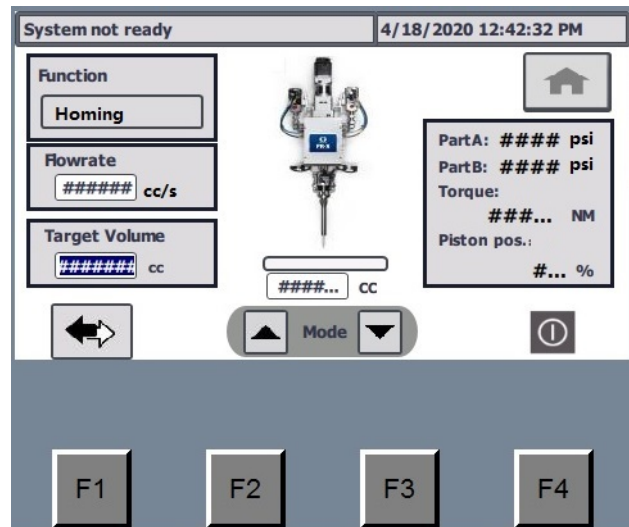

Fig. 37 Manual Screen 1

7. Dispense several full stroke shots until the PR-X Metering Unit (H) is free of air.

Ratio Check Procedure

Perform the Ratio Check Procedure at startup and after



rebuild.

1. Weigh six small cups and label as indicated. Record weights.

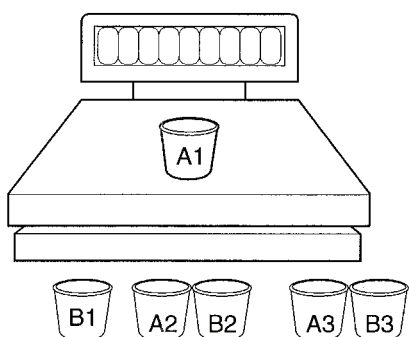

2. Remove Static Mixer Package (AG) from MD2 Dispense Valve (AE).
3. Install the ratio check nozzle onto the MD2 Dispense Valve (AE).



4. Dispense into a waste container to prime the ratio check nozzle.
5. Place cups as indicated under ratio check nozzle and cycle the machine one time.
6. Repeat until all three sets of cups have been used.
7. Re-weigh all six cups and record weights.
8. Subtract weight of empty cups from weight of filled cups to get material weights.
9. Complete ratio calculations.

The following formula can be used when the density or specific gravity of both the “A” and “B” components are known and only one of the ratios:

$$\frac{\text{Weight Ratio}}{\text{Volume Ratio}} = \frac{\text{Specific Gravity}}{\text{Specific Gravity}}$$

Example:

A material has a weight ratio of 10:1, the “A” material has a specific gravity of 1.20 and the “B” material has a specific gravity of 1.00. To calculate volume ratio:

$$\frac{10:1}{\text{Volume Ratio}} = \frac{1.20}{1.00}$$

$$\text{Volume Ratio} = \frac{10}{1.20}$$

$$\text{Volume Ratio} = 8.33:1$$

Shutdown



1. Remove Static Mixer Package (AG) from MD2 Dispense Valve (AE).
2. Place a waste container below the MD2 Dispense Valve (AE) and activate a small shot to flush mixed material out of the valve.
3. Perform the **Pressure Relief Procedure** on page 42.
4. Turn off the system power.
5. Wipe the Nose Piece (AH) with a clean rag, being careful to avoid contact between dispense materials.
6. Install the PTFE night cap (1:1 valves - 15K652) and retaining nut (15K688) on the MD2 Dispense Valve (AE).

Pressure Relief Procedure

 Follow the Pressure Relief Procedure whenever you see this symbol.

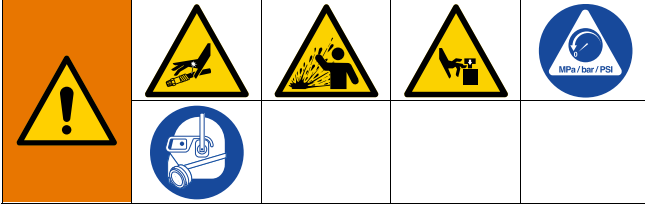

This equipment stays pressurized until pressure is manually relieved. To help prevent serious injury from pressurized fluid, such as skin injection, splashing fluid and moving parts, follow the Pressure Relief Procedure when you stop dispensing and before cleaning, checking, or servicing the equipment.

1. Remove Static Mixer Package (AG) from MD2 Dispense Valve (AE).
2. Close the Bleed-type Master Air Valve (G, page 7) (required in the system).
3. Place a waste container below the MD2 Dispense Valve (AE).
4. Go to System main screen of the PR-X Control Unit (J), then select 'System Relief'.

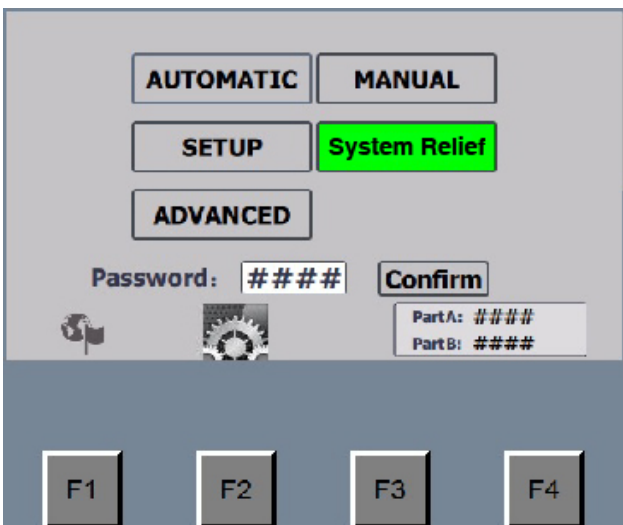

FIG. 38 System Main Screen

5. Turn off the system power and the air supply when the fluid pressure drops to ZERO.

Flush the Equipment



To avoid fire and explosion, always ground equipment and waste container. To avoid static sparking and injury from splashing, always flush at the lowest possible pressure.

- Flush out old fluid with new fluid or flush out old fluid with compatible solvent before introducing a new fluid.
- Use the lowest possible pressure when flushing.
- All fluid components are compatible with common solvents.
- To flush the entire system, circulate through the MD2 Dispense Valve (AE), then drain the valve.

Software Setup (For Profinet Communication Mode Only)

If you want to change the PR-X system from I/O communication mode to Profinet communication mode, order SD card 18C277. Insert the SD card in the indicated slot before setting the IP address.

NOTE: Do not remove the SD card once it is inserted into the control box, because the control box can not work without the SD card.

Insert the SD card

1. Turn off the control box power.
2. Remove the control box cover.
3. Insert the SD card.

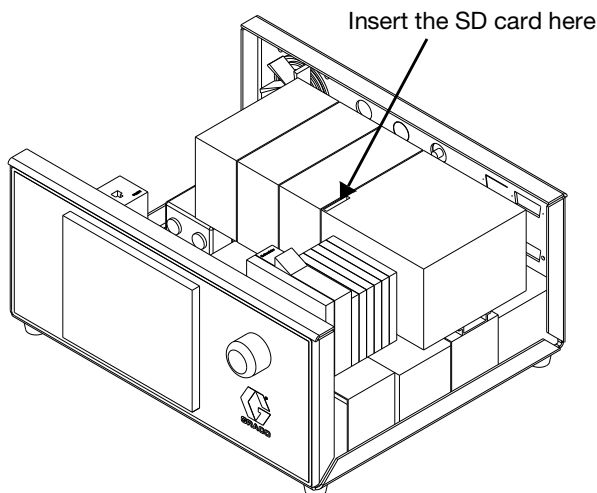

FIG. 39 Insert the SD Card

Change the control box IP address

After inserting the SD card or establishing Profinet communication mode, the PLC IP address in the control box may be changed, causing the data on the screen is displayed as #####.

In this case, it is necessary to change IP address of the PLC and HMI, and connect HMI IP address in the control box.

It is necessary to ensure that the PLC IP address is same as the HMI connection address and is in same subnet with the HMI IP address.

PLC IP Address Setup

1. Start PR-X control unit and push 'Settings' button on the 'Start Center' screen.

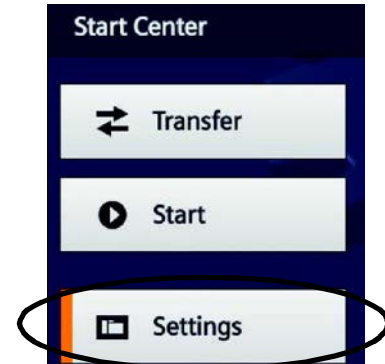

2. Select 'Service & Commissioning' on the 'Settings' screen.

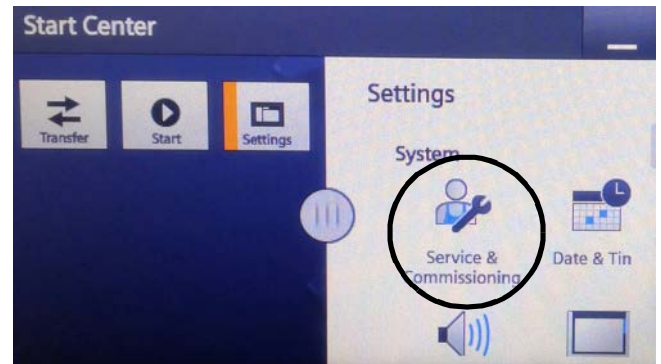

3. Select 'Assign PLC Address' from the 'Service & Commissioning' list, then touch the cycle in the middle of screen to see complete information.

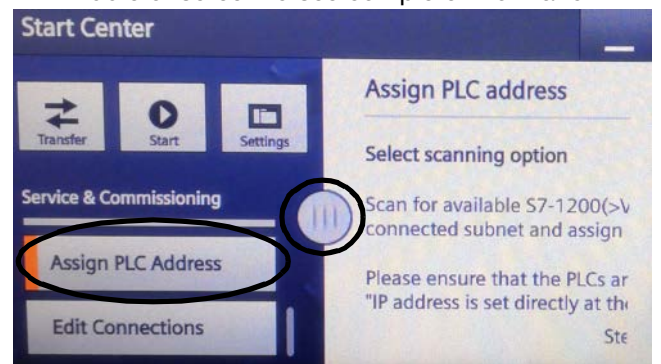

Operation

- 4. Select 'Accessible devices in target subnet' on the 'Step 1/4' screen. Then select '>' to proceed to the next screen.

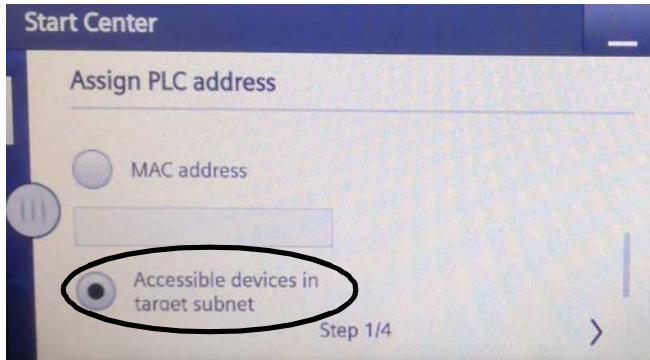

- 6. Edit IP address directly on the 'Step 3/4' screen. Then select '>' to proceed to the next screen.

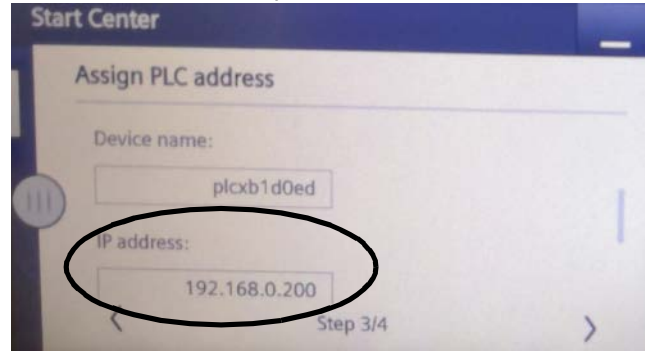

- 5. Select 'Start search' button on the 'Step 2/4' screen, HMI will then find PLC in the Net. Select the device with the IP address you want to change. Then select '>' to proceed the next screen.

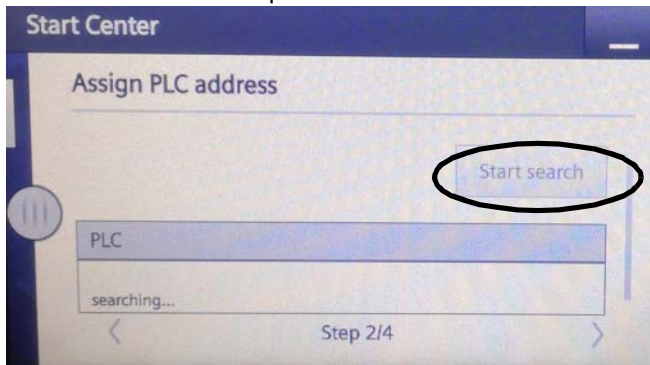

- 7. Choose 'Accept' on the 'Step 4/4' screen.

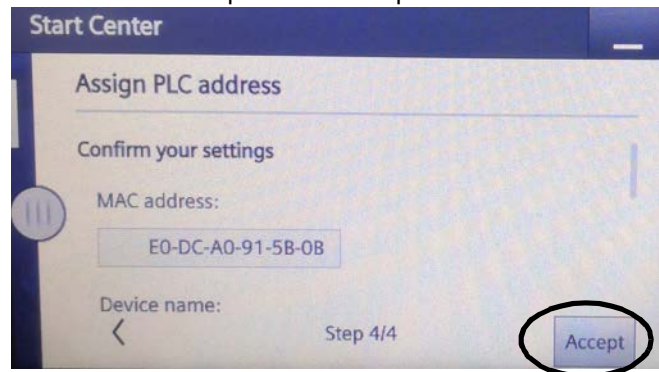

- 8. Select 'Edit Connections' from the 'Service & Commissioning' list. Next, touch the middle cycle to open the whole screen.

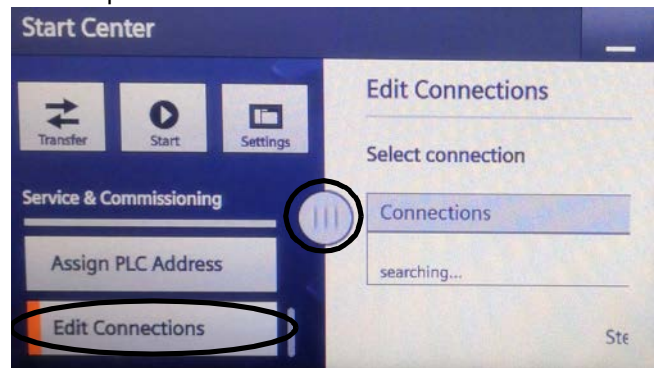
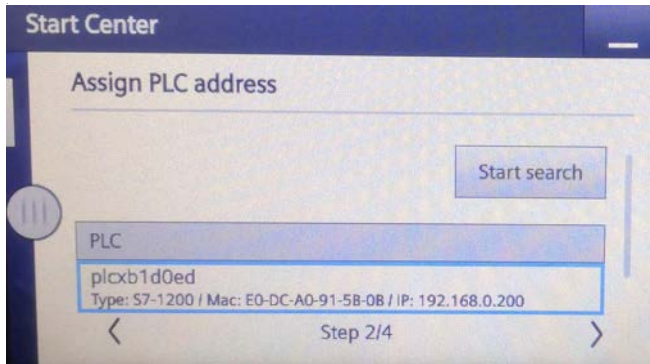

9. Select 'HMI_Connection_1' on the 'Step 1/3' screen. Then select '>' to proceed to the next screen.

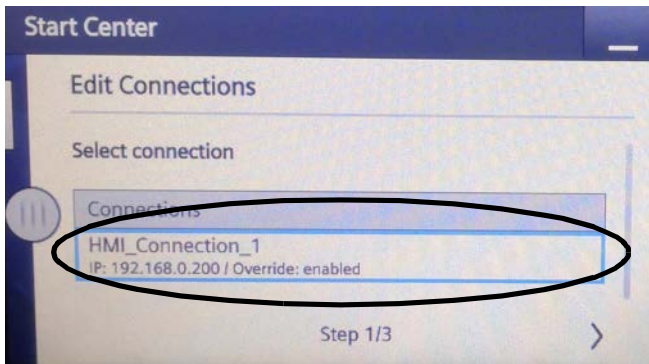

10. Select 'ON' for the 'Override' item on the 'Step 2/3' screen. Then select '>' to proceed to the next screen.



11. Select 'Accept' on the 'Step 3/3' screen.

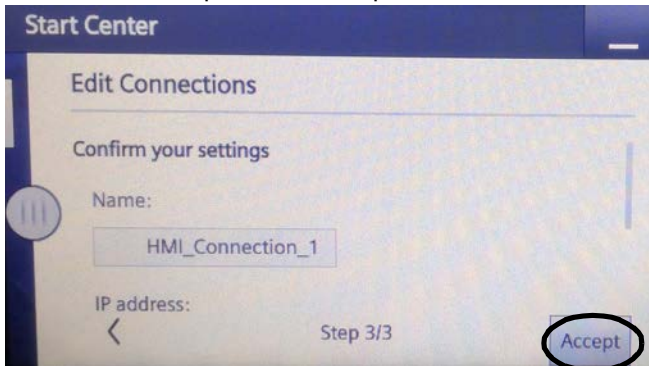

12. Return to the 'Start Center' screen and restart HMI before HMI IP address setup.

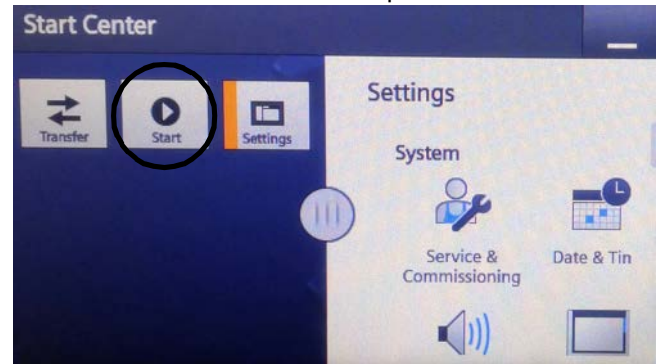

HMI IP Address Setup

1. Start PR-X control unit and select 'Settings' on the 'Start Center' screen.

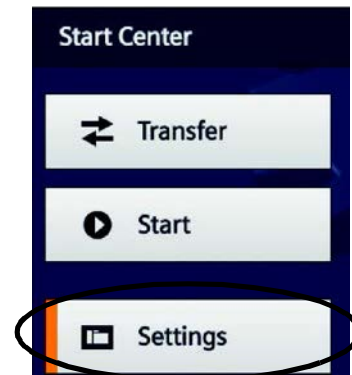

2. Select 'Network Interface' on the 'Settings' screen.

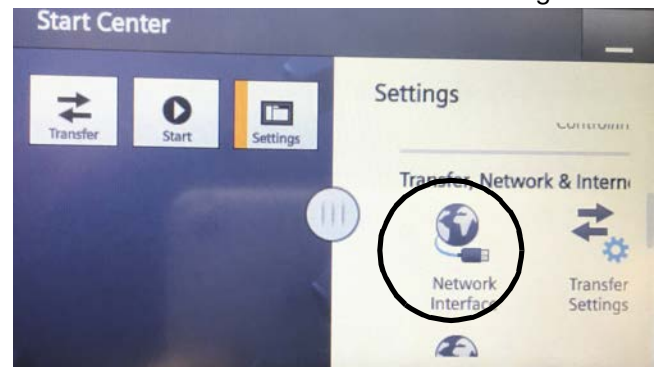

Operation

3. Edit IP address directly from the 'Network Interface' screen.

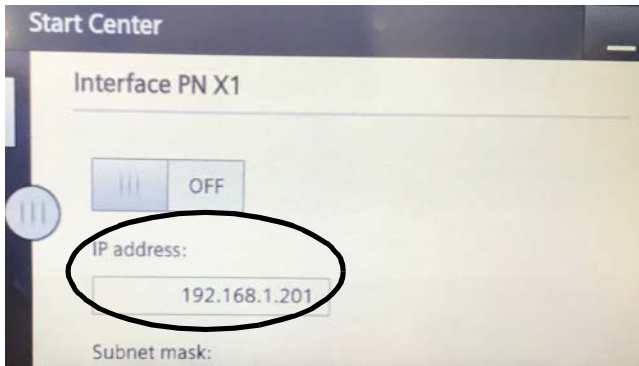

4. Return to the 'Start Center' main screen and restart HMI.

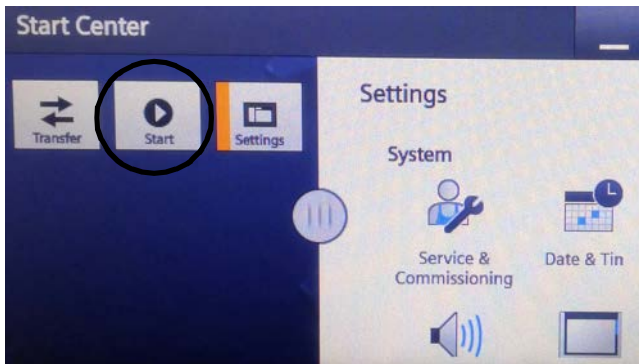

Maintenance

Preventive Maintenance

There is a grease filled secondary seal/bearing area on each valve shaft (MD2 Dispense Valve (AE) and Inlet Valve (AK). Every 10,000 cycles or twice each month, new grease should be flushed across this area.

To grease the valve:

1. Remove the fitting from each side of the front or back of the valve. For the detailed information, please check MD2 Dispense Valve (AE) Instruction and Parts Manual 312185 and 1K Ultra-Lite Instructions and Part List Manual 308876.
2. Pump grease (115982) with grease gun (117792) across the valve until clean grease comes out the other side.
3. Reinstall the fitting.

Maintenance Schedule

Item	Task	Daily	Monthly	Quarterly	Yearly
1	Inspect cable and air tubes for leaks	✓			
2	Clean up all material and dust of supply pump	✓			
3	Clean dust and foreign matter from the PR-X metering unit and the PR-X control unit	✓			
4	Inspect fluid lines and adapters for leaks	✓			
5	Inspect inlet air filter equipment, expel water and clean filter	✓			
6	Use dry and clean compressed air to remove dust buildup on motor, control boards and fan		✓		
7	Clean and grease Inlet Valve (AK) and MD2 Dispense Valve (AE) and repair broken seal components (see valve manual)		✓		
8	Inspect supply pumps' wet cup, cleanup leaking material and fill TSL oil		✓		
9	Inspect leaking holes (AL) on the both side of PR-X metering unit		✓		
10	Grease the ball screw, slides and bearings			✓	
11	Inspect sealant condition with high pressure and repair broken seal components			✓	
12	Inspect and tighten screws and nuts on moving parts			✓	
13	Verify sensors are affixed correctly			✓	
14	Inspect and calibrate pressure sensor				✓
15	Replace PR-X metering unit's pistons and O-rings				✓
16	Replace valve seal components (MD2 Dispense Valve (AE) and Inlet Valve (AK))				✓
17	Replace supply pump seal components				✓

Recycling and Disposal

End of Product Life

At the end of the product's useful life, dismantle and recycle it in a responsible manner.

- Perform the **Pressure Reduction Procedure** on page 42.
- Drain and dispose of fluids according to applicable regulations. Refer to the material manufacturer's Safety Data Sheet.
- Remove motors, circuit boards, LCDs (liquid crystal displays), and other electronic components. Recycle according to applicable regulations.
- Do not dispose of electronic components with household or commercial waste. 
- Deliver remaining product to a recycling facility.

Troubleshooting

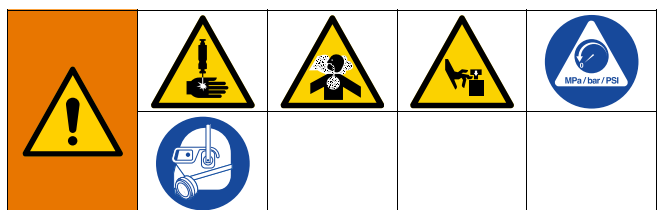

1. Follow **Pressure Relief Procedure** on page 42, before checking or repairing the system.
2. Disconnect AC power from the system.

Problem	Cause	Solution
Display module completely dark	No power	Verify AC power switch (BM) is ON
	Thrown breaker	Check machine breakers and reset
	Loose connection	Tighten screen data cable
	Bad display module	Replace display module
No or incorrect amount of material dispensed from either side	MD2 Dispense Valve (AE) closed	Verify supply air pressure
	Needle or Static Mixer Package (AG) clogged	Replace needle or Static Mixer Package (AG)
	Supply pump ball valve closed (if installed)	Open ball valve
	Pail empty	Exchange pail
	Supply pump clogged	Clean supply pump
	Air in PR-X metering unit	Purge and prime the system
Significant material leaking from pump seal	Pump shaft and/or shaft seal worn	Remove pump shaft assembly and reinstall pump rebuild kit
Material weight incorrectly dispensed	Needle or Static Mixer Package (AG) clogged	Replace needle or Static Mixer Package (AG). Incorporate purge timer or decrease purge timer delay to prevent Static Mixer Package (AG) blockage
	MD2 Dispense Valve (AE) or fluid lines clogged	Clean MD2 Dispense Valve (AE) or fluid lines
	MD2 Dispense Valve (AE) opened or closed incorrectly	<ol style="list-style-type: none"> 1. Verify MD2 Dispense Valve's (AE) inlet air pressure. 2. Inspect MD2 Dispense Valve (AE) air cylinder and adapters for leaks.
	Input air reduced or removed	Reconnect input air line to system. Increase air pressure regulator adjustment
	Inlet Valve (AK) not closed (if installed)	<ol style="list-style-type: none"> 1. Inspect the Inlet Valve (AK) for wear and tear. 2. Verify rotary cylinder inlet pressure.
	Inlet 1K Ultra-Lite valve leaking (if installed)	Inspect needle and seal components
	Piston worn out or broken	Replace piston

Problem	Cause	Solution
Leakage from Static Mixer Package (AG) tip	Air in Static Mixer Package (AG)	Slow speed purging
	MD2 Dispense Valve (AE) not closed	<ol style="list-style-type: none"> 1. Verify MD2 Dispense Valve's (AE) inlet air pressure. 2. Clean blockage between needle and seat. 3. Verify solenoid valve status.
	MD2 Dispense Valve (AE) needle and/or seat worn out (pressure reduces after closing the valve)	Replace MD2 Dispense Valve (AE) needle and/or seat
	Damaged or missing gasket (O-ring) between seat and housing (hard seat only)	Replace gasket (O-ring)
	Insufficient valve off time	Increase valve off time to release pressure in Static Mixer Package (AG)
High pressure	MD2 Dispense Valve (AE) clogged	Clean MD2 Dispense Valve (AE)
	Material in Static Mixer Package (AG) and/or needle cured	Replace Static Mixer Package (AG) and/or needle
	Dispense speed unsuitable for Static Mixer Package (AG) and needle	<ol style="list-style-type: none"> 1. Replace the current Static Mixer Package (AG) and/or needle with a bigger gauge. 2. Slow down dispensing speed to decrease working pressure (continuous and stable dispensing pressure should be within a range of 150-400 psi).
	Pressure sensor error	Replace pressure sensor
Pressure imbalance	One side of MD2 Dispense Valve (AE) or fluid lines clogged	Clean the high pressure side of MD2 Dispense Valve (AE) or fluid lines
	Air or hole in material	Prime the system
	Low pressure side piston worn out	Replace the piston
"Home" error	Error not reset	Pull up E-stop button and press "reset"
	Pressure higher than set point	Go to the Advanced Screen of control box, select 'Dispense valve' to open MD2 Dispense Valve (AE) to reduce pressure
	"Home" button flashing and waiting	<ol style="list-style-type: none"> 1. Verify reload pressure value is correctly set. 2. Verify air supply. 3. Inspect low level sensor status. 4. Confirmed inlet ball valve is opened (if installed). 5. Verify pail is not empty. 6. Verify supply pump is working.
	Servo motor alarm	<ol style="list-style-type: none"> 1. Inspect ball screw and slides are functional. 2. Verify motor and encoder cable are connected.

Problem	Cause	Solution
System does not dispense or dispenses in the incorrect amount/mode	Signal error between platform and PR-X control unit	1. Verify signal was correctly sent and received. 2. Verify signal cable is correctly connected.
	Wrong "Dispense mode"	Choose correct mode
	Wrong "Dispense type"	Choose correct type
	Wrong mode and/or type trigger method	Choose correct trigger method in "Setup" menu (job can be triggered by outside signal or manually)
Incorrect pressure value	Loose pressure sensor cable or adapters	Exchange cable, tighten adapters
	Pressure sensor error	Replace pressure sensor
	Pressure sensor signal incorrect	Calibrate pressure sensor

Repair



6. Open the top cover of the Junction Box (AA) and loosen the four fix screws in the cylinder housing (10202a). Next, take off the Junction Box Assembly (AA).

Prepare Machine for Piston/Cylinder Replacement Kit Installation

NOTE: Graco suggests using TSL™ only in repair procedures. All procedures should be performed by an appropriate professional.

1. Perform the step 1 to step 4 of **Pressure Relief Procedure** on page 42.
2. Turn off the air supply when the fluid pressure drops to ZERO.
3. Go to the Advanced Screen of the PR-X Control Unit (J). Set the move speed at about 0.2 cc/s, then jog select “Piston move down” until the lower switch light is activated.

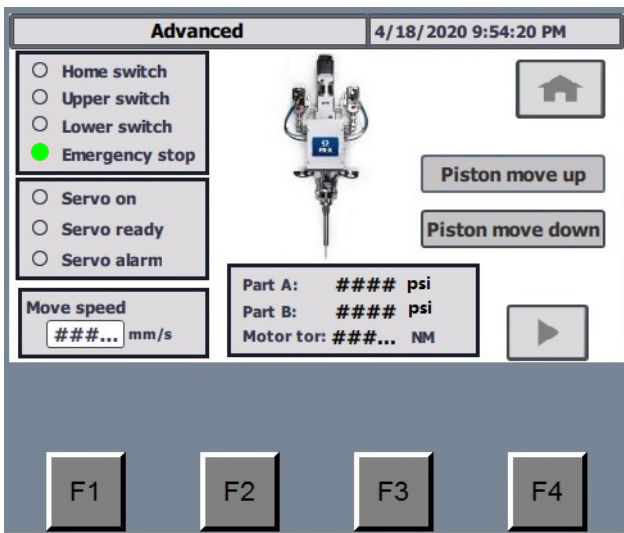

FIG. 40 Advanced Screen 1

NOTE: To open the Advanced mode, the operator must enter the password **1492**.

4. Turn off the system power.
5. Disconnect all cables and tubes from Junction Box Assembly (AA).

Disassemble Cylinder

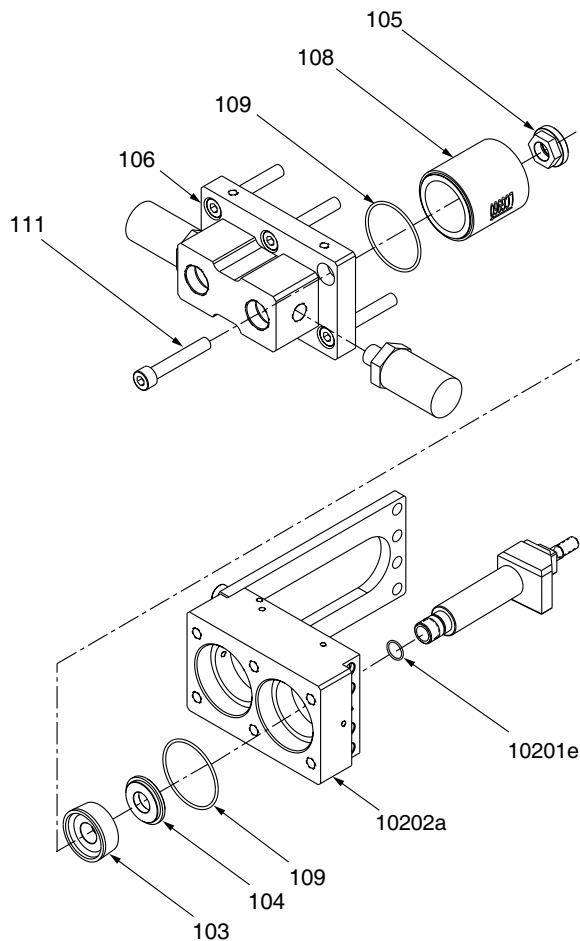

Fig. 41 Disassemble Cylinder

1. Remove the MD2 Dispense Valve (AE).
2. Remove the six end cap screws (111).
3. Remove the cylinder end caps (106).
4. Remove the cylinder (108) and O-rings (109) from the cylinder housing (10202a).
5. Use the specific tools remove the piston nut (105).
6. Remove the piston (103) and piston plate (104) from the rod.
7. Remove the O-ring (10201e) from the rod.
8. Clean all parts that have been removed.

Install Cylinder

1. Install the new O-ring (10201e) to the rod with TSL oil.
2. Install the piston plate (104) and the new piston in the correct direction.
3. Install the piston nut (105) (Tighten the piston screw with correct torque).
4. Lubricate the new O-rings (109) and inside the cylinder (108) with TSL oil.
5. Insert the lubricated O-rings (109) into the grooves of the Cylinder housing (10202a) and cylinder end caps (106).
6. Carefully slide the end of the cylinder into the cylinder housing (10202a) in the correct direction. Ensure the cylinder doesn't damage the sides of the piston as the cylinder is inserted.
7. Install the cylinder end caps (106).
8. Secure cylinder in place with the six end cap screws (111). Diagonally tighten the screw by slowly and progressively increasing torque until the screws are securely housed.
9. Install the Junction Box Assembly (AA) and connect all cables or tubes.
10. Install the MD2 Dispense Valve (AE).
11. Turn on the air supply and power.

Prepare Machine for Operation

1. Pressurize Supply Pump Systems A and B (K and L) connected to the PR-X Inlet Valve (AK). Perform **Prime the System** on page 40.
2. Perform the **Ratio Check Procedure** on page 41.
3. Install Static Mixer Package (AG).
4. Dispense several full stroke shots until the PR-X Metering Unit (H) is free of air and there is no leakage at the nose piece after shutoff.

Parts

Overview

Parts Description	Page
1. PR-X System, Pump Feed, Direct, 25R128, 25R129, 2001180, 2001181, 2003138, 2005007 and 2005008	55
2. PR-X Base Assembly, Pump Feed	56
2.1. Fixed Ratio Base Assembly	58
2.1.1. Junction Box Assembly and Fixed Ratio Base Frame Assembly	60
a) Junction Box Assembly	62
b) Fixed Ratio Base Frame Assembly	64
2.1.2. Power Transmission Assembly	66
a) Ball Screw Assembly	67
b) PR-X Drive	68
3.1. Supply Pump Assembly	69
3.1.1. Pump Slide Assembly	70

PR-X System, Pump Feed, Direct, 25R128, 25R129, 2001180, 2001181, 2003138, 2005007 and 2005008

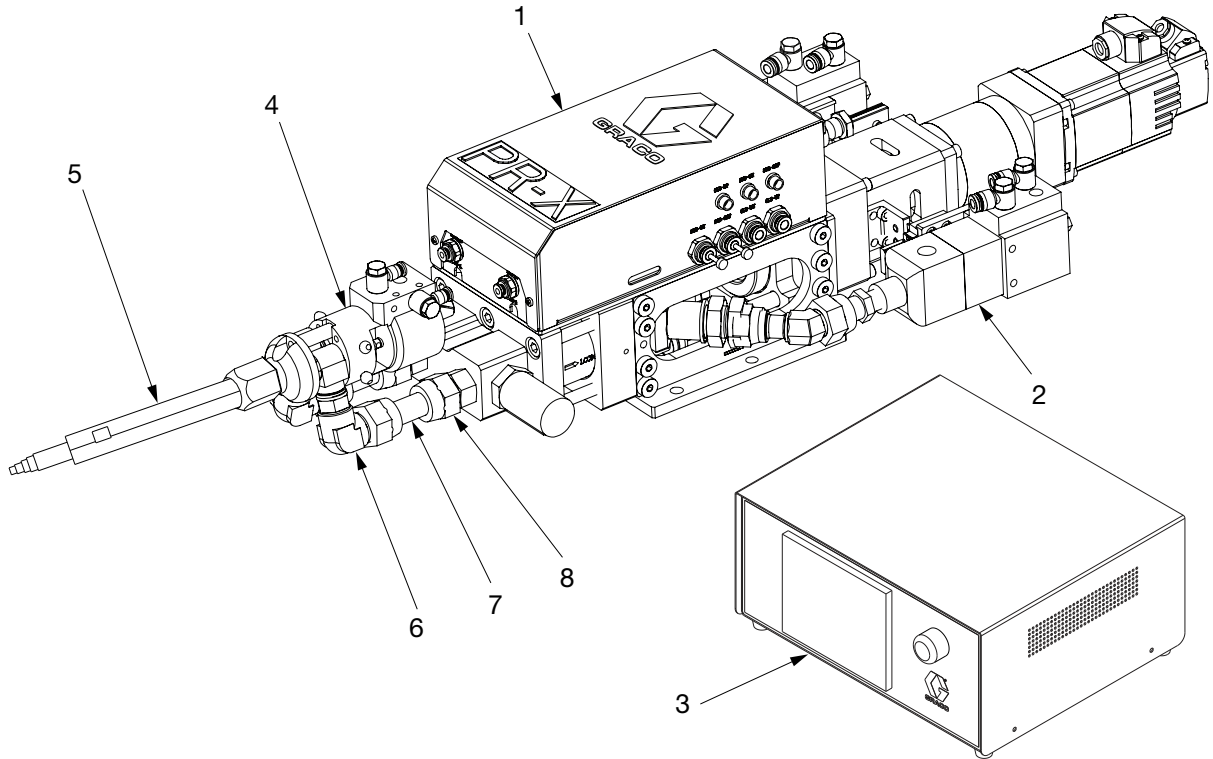
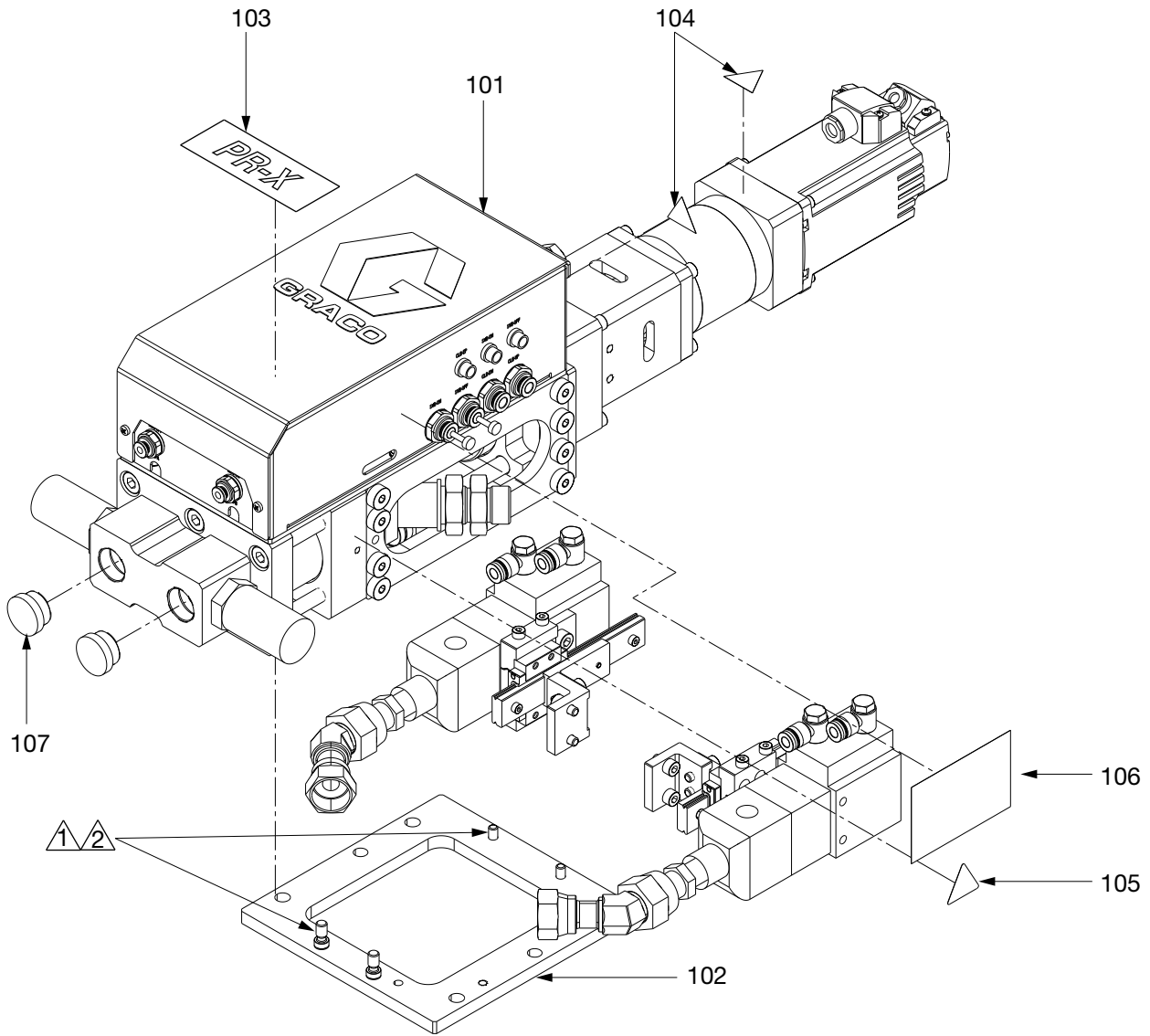

FIG. 42: PR-X System, Pump Feed, Direct

Ref.	Part	Description	Quantity							
			25R128	25R129	2001180	2001181	2003138	2005007	2005008	
1	----	ASSEMBLY, PR-X base, SST, 50 cc, 1:1, see page 56	1						1	
	----	ASSEMBLY, PR-X base, HW, 50 cc, 1:1, see page 56		1						1
	----	ASSEMBLY, PR-X base, SST, 37 cc, 1:1, see page 56			1					
	----	ASSEMBLY, PR-X base, HW, 37 cc, 1:1, see page 56				1				
	----	ASSEMBLY, PR-X base, SST, 25 cc, 1:1, see page 56					1			
2	----	ASSEMBLY, supply pump, SST, see page 69	1		1		1	1		
	----	ASSEMBLY, supply pump, HW, see page 69		1		1				1
3	18C035	BOX, control, PR-X	1	1	1	1	1			
	2005006	BOX, control, PR-X, 10 m						1	1	
4	255180	VALVE, MD2, SST	1		1		1	1		
	255901	VALVE, MD2, HW		1		1				1
5	2000924	KIT, THREAD, SHROUD, MIXER, 1:10, 08-24T	1	1	1	1	1	1	1	1
6	18C123	FITTING, UN13/16-16, UN9/16-18	2	2	2	2	2	2	2	2
7	18C122	FITTING, UN13/16-16, female	2	2	2	2	2	2	2	2
8	18C121	FITTING, UN13/16-16, male	2	2	2	2	2	2	2	2

PR-X Base Assembly, Pump Feed





-  Torque to 3.0-3.7 ft-lb (4-5 N•m).
-  Apply sealant, Anaerobic, blue.

FIG. 43: PR-X Base Assembly, Pump Feed

PR-X Base Assembly, Pump Feed

Ref.	Part	Description
101	----	BASE, fixed ratio, PR-X, SST, 50 cc, 1:1, see page 58
	----	BASE, fixed ratio, PR-X, HW, 50 cc, 1:1, see page 58
	----	BASE, fixed ratio, PR-X, SST, 37 cc, 1:1, see page 58
	----	BASE, fixed ratio, PR-X, HW, 37 cc, 1:1, see page 58
	----	BASE, fixed ratio, PR-X, SST, 25 cc, 1:1, see page 58
102	----	ASSEMBLY, supply pump, SST, see page 69
	----	ASSEMBLY, supply pump, HW, see page 69
103	----	BRANDING LABEL
104*	189930	LABEL, caution, electric shock
105*	15H108	LABEL, caution, pinch
106	----	SERIES LABEL
107	----	PLUG, UN13/16-16

Quantity						
25R128	25R129	2001180	2001181	2003138	2005007	2005008
1					1	
	1					1
		1				
			1			
				1		
1		1		1	1	
	1		1			1
1	1	1	1	1	1	1
2	2	2	2	2	2	2
2	2	2	2	2	2	2
1	1	1	1	1	1	1
2	2	2	2	2	2	2

* Replacement safety labels, tags, and cards are available at no cost.

Fixed Ratio Base Assembly

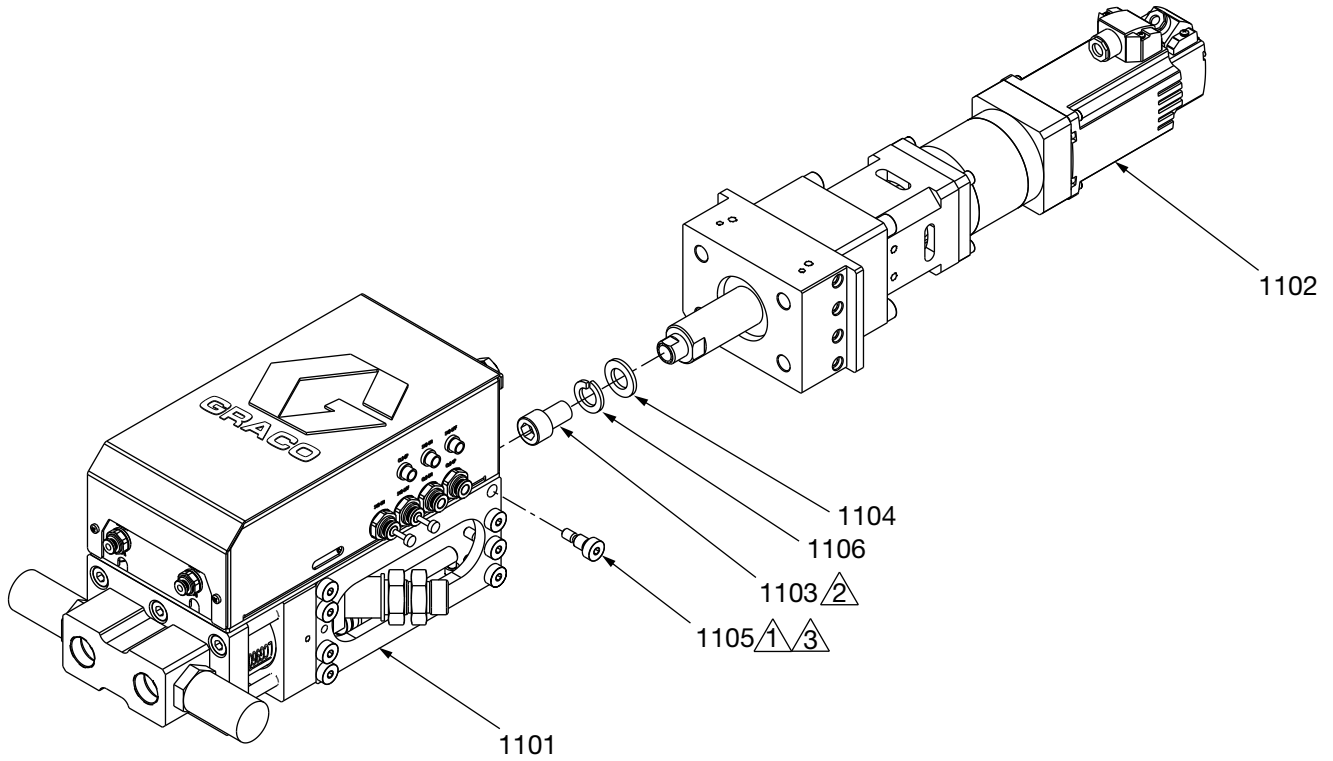

- ▲ Torque to 3.7-4.4 ft-lb (5-6 N•m).
- ▲ Torque to 11.1 ft-lb (15 N•m).
- ▲ Apply sealant, Anaerobic, blue.

FIG. 44: Fixed Ratio Base Assembly

Fixed Ratio Base Assembly

Ref.	Part	Description
1101	----	ASSEMBLY, junction box and fixed ratio base frame, SST, 50 cc, 1:1,see page 60
	----	ASSEMBLY, junction box and fixed ratio base frame, HW, 50 cc, 1:1,see page 60
	----	ASSEMBLY, junction box and fixed ratio base frame, SST, 37 cc, 1:1,see page 60
	----	ASSEMBLY, junction box and fixed ratio base frame, HW, 37cc, 1:1,see page 60
	----	ASSEMBLY, junction box and fixed ratio base frame, SST, 25cc, 1:1,see page 60
1102	----	ASSEMBLY, power transmission, see page 66
1103*	----	SCREW, M12 x 1.75-20, SST
1104*	----	WASHER, flat, M12
1105	18B949	SCREW, shoulder, DIA 8,M6
1106*	----	WASHER, spring, DIA 12

Quantity						
25R128	25R129	2001180	2001181	2003138	2005007	2005008
1					1	
	1					1
		1				
			1			
				1		
1	1	1	1	1	1	1
1	1	1	1	1	1	1
1	1	1	1	1	1	1
8	8	8	8	8	8	8
1	1	1	1	1	1	1

* Parts included in Kit 25R588 (purchase separately).

Junction Box Assembly and Fixed Ratio Base Frame Assembly

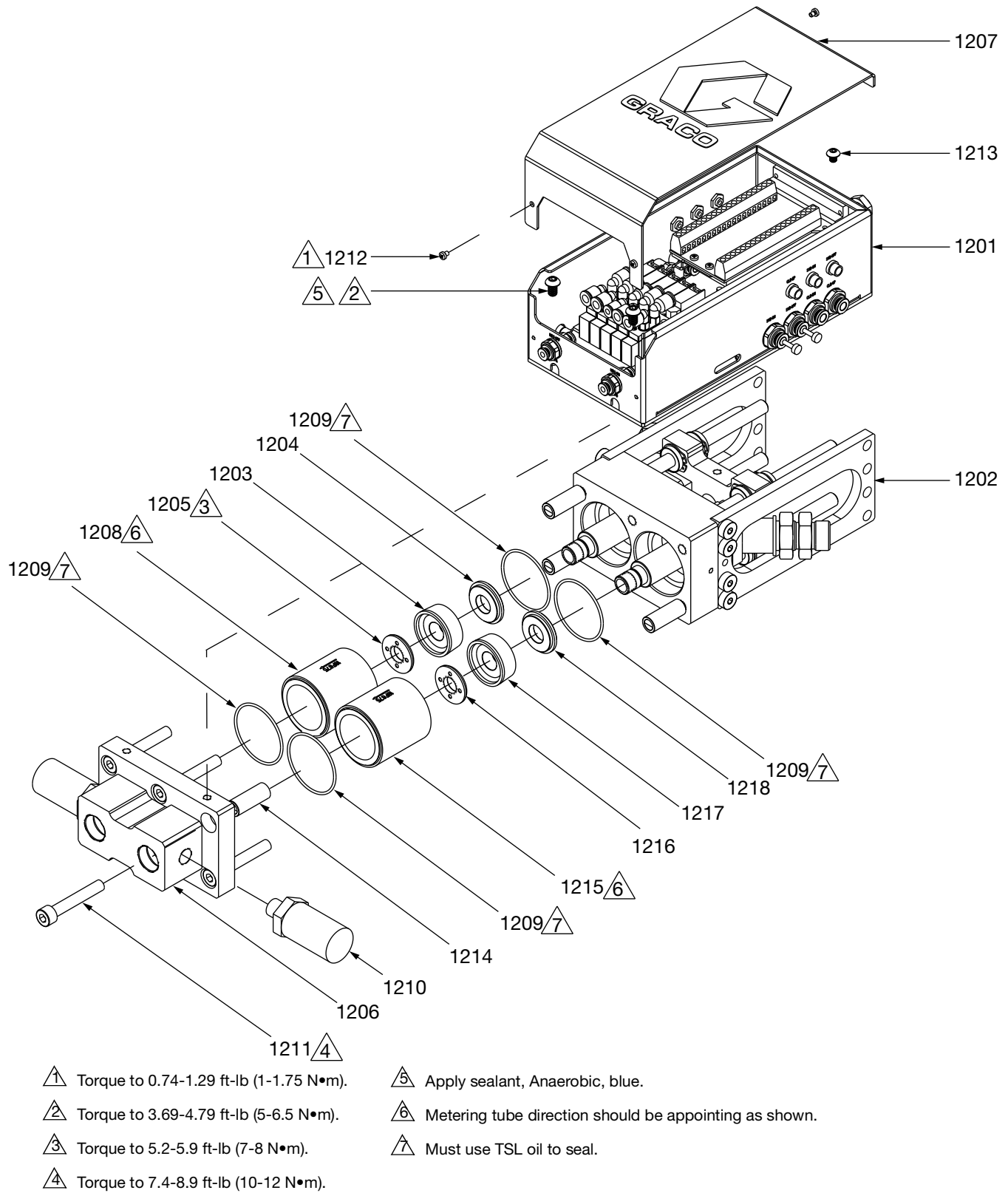

Fig. 45: Junction Box and Fixed Ratio Base Frame Assembly

Junction Box Assembly and Fixed Ratio Base Frame Assembly

Ref.	Part	Description	Quantity							
			25R128	25R129	2001180	2001181	2003138	2005007	2005008	
1201	----	ASSEMBLY, junction box, see page 62	1	1	1	1	1	1	1	1
1202	----	ASSEMBLY, fixed ratio base frame, see page 64	1	1	1	1	1	1	1	1
1203*†	18B482	PISTON, 960	2	2	1	1		2	2	2
1204*†	18B952	PLATE, support back, tube	2	2	1	1		2	2	2
1205*†	2001163	PLATE, support front, tube	2	2	1	1		2	2	2
1206	18B954	CYLINDER END CAPS	1	1	1	1	1	1	1	1
1207	----	COVER, control	1	1	1	1	1	1	1	1
1208*	18F875	CYLINDER, 25, SST	2		1			2		
†	18F876	CYLINDER, 25, CER		2		1				2
1209*†♣✓	120874	O-RING	4	4	4	4	4	4	4	4
1210	18C018	SENSOR, pressure, fluid outlet	2	2	2	2	2	2	2	2
1211	18B956	SCREW, M8 x 1.25-50, SST, Partially	6	6	6	6	6	6	6	6
1212	----	SCREW, M3 x 0.5-4, pan head, SST	4	4	4	4	4	4	4	4
1213	----	SCREW, M5 x 0.8-6, button head, hex	2	2	2	2	2	2	2	2
1214	----	SLEEVE, screw	4	4	4	4	4	4	4	4
1215♣	18F877	CYLINDER, 15, SST			1		2			
✓	18F878	CYLINDER, 15, CER				1				
1216♣✓	2001164	PLATE, support front, tube			1	1	2			
1217♣✓	2001162	PISTON, 480			1	1	2			
1218♣✓	18C218	PLATE, support back, tube, 400			1	1	2			

* Parts included in Kit 2001559 (purchase separately).

† Parts included in Kit 2001560 (purchase separately).

♣ Parts included in Kit 2001561 (purchase separately).

✓ Parts included in Kit 2001562 (purchase separately).

Junction Box Assembly

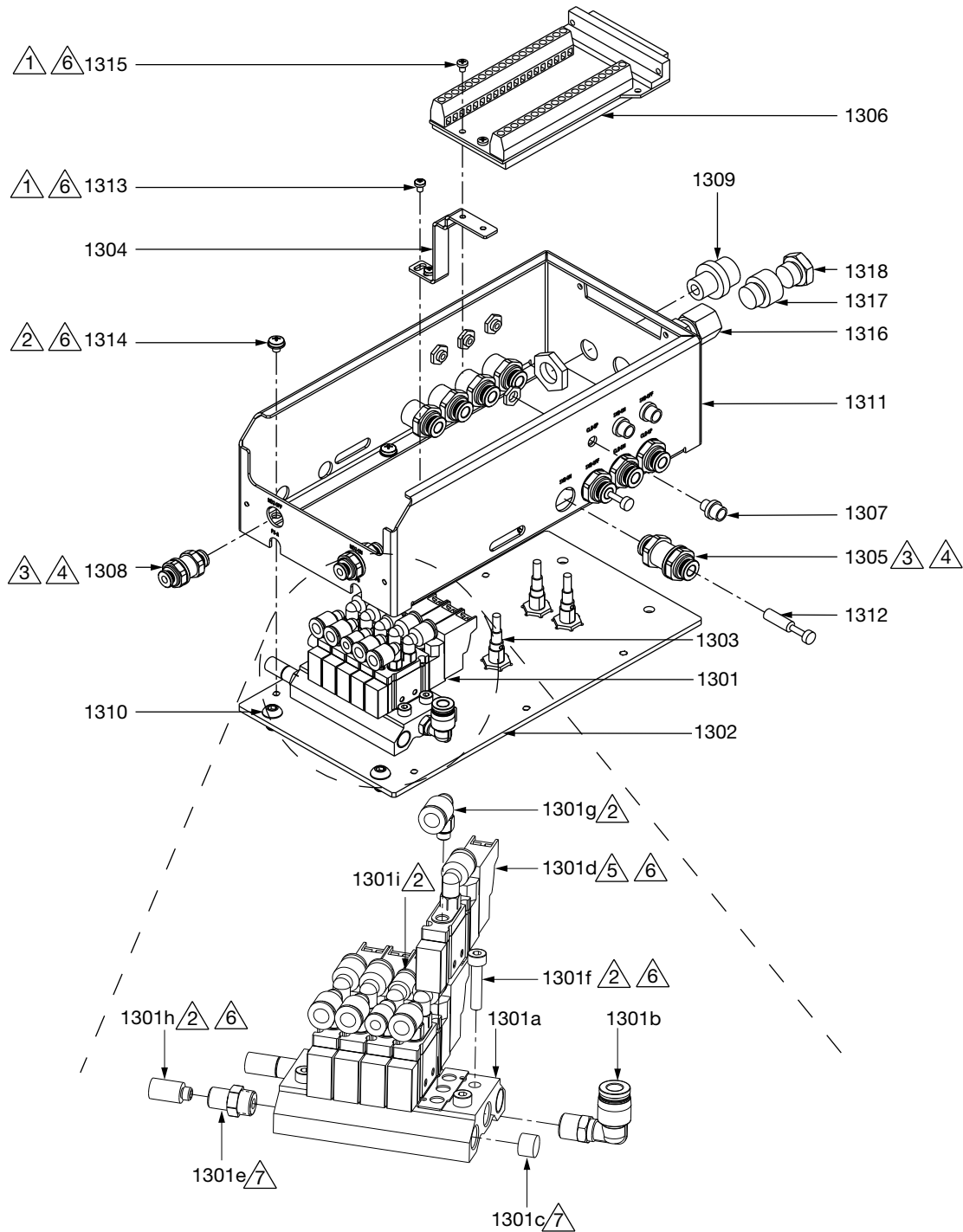

- ⚠1 Torque to 0.74-1.29 ft-lb (1-1.75 N•m).
- ⚠2 Torque to 1.70-2.58 ft-lb (2.3-3.5 N•m).
- ⚠3 Fitting top surface to mounting plate 12±0.5 mm.
- ⚠4 Rubber gasket should be assembled on the outer surface.
- ⚠5 Torque to 0.52-0.92 ft-lb (0.7-1.25 N•m).
- ⚠6 Apply sealant, Anaerobic, blue.
- ⚠7 Apply sealant, pipe, SST.

FIG. 46: Junction Box Assembly

Junction Box Assembly

Ref.	Part	Description	Qty.
1301	----	ASSEMBLY, solenoid valve	1
1301a	18B910	KIT, manifold, solenoid valve	1
1301b	18B911	FITTING, DIA 6, PT1/8	1
1301c	18B912	PLUG, socket, PT1/8	3
1301d	18B913	VALVE, solenoid, 2 way, 24 VDC	5
1301e	18B914	FITTING, M5 x 0.8, Rc1/8	2
1301f	18B915	SCREW, M4 x 0.7-20, socket	4
1301g	18B916	FITTING, DIA 6, M5 x 0.8	8
1301h	18B917	MUFFLER, M5	2
1301i	18B918	FITTING, DIA 4, M5 x 0.8	2
1302	----	PLATE, top	1
1303	18B920	SENSOR, close	3
1304	18B921	BRACKET, support	1
1305	18B922	FITTING, DIA 6, M14 x 1	8
1306	18B923	TERMINAL, integrated, connector	1
1307	18B924	FITTING, PIN 4, M6	6
1308	18B925	FITTING, DIA 4, M12 x 1	2
1309	18B926	FITTING, PIN 3, M12	2
1310	----	SCREW, M6 x 1-10, button head, hex	2
1311	----	FRAME, control	1
1312	18B929	PLUG, DIA 6	4
1313	----	SCREW, M3 x 0.5-4, Phillips	2
1314	----	SCREW, M4 x 0.7-5, Phillips, w washer	6
1315	----	SCREW, M3 x 0.5-4, pan head, SST	2
1316	18B933	FITTING, DIA 6, NPT 1/4	1
1317	18B934	FITTING, DIA 6, NPT 1/4 male	1
1318	18B935	FITTING, DIA 1/4 in, NPT 1/4 male	1

Fixed Ratio Base Frame Assembly

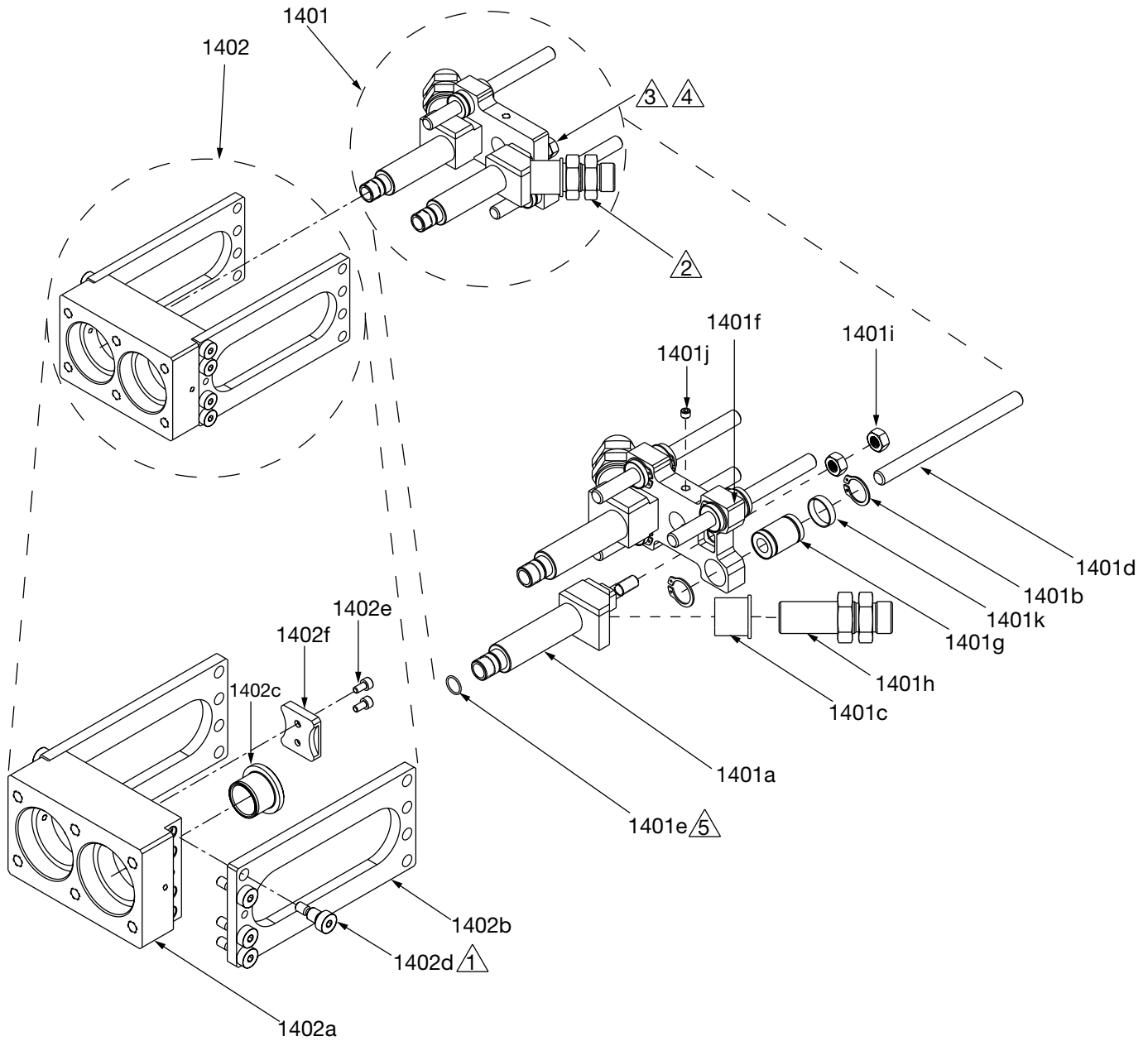

△1 Torque to 2.95-3.69 ft-lb (4-5 N•m).

△2 Torque to 3.69-4.42 ft-lb (5-6 N•m).

△3 Torque to 7.4-8.9 ft-lb (10-12 N•m).

△4 Apply sealant, Anaerobic, blue.

△5 Must use TSL oil to seal.

FIG. 47 Fixed Ratio Base Frame Assembly

Fixed Ratio Base Frame Assembly

Ref.	Part	Description	Qty.
1401	----	ASSEMBLY, piston rod	1
1401a*	----	ROD, piston	2
1401b♣	----	WASHER	8
1401c†	----	BUSH	2
1401d♣	----	ROD, guide	2
1401e*	18B940	O-RING	2
1401f	18D760	BLOCK, push	1
1401g♣	----	BEARING	2
1401h†	----	FITTING, w nut	2
1401i*	----	NUT, M8	4
1401j	----	SCREW, SET, M6 x 1.0-5, flat	2
1401k♣	----	WASHER	4
1402	----	ASSEMBLY, block, piston rod	1
1402a	18D946	SEAT, tube	1
1402b	18B947	PLATE, side	2
1402c	18B948	SLEEVE, guide	2
1402d	18B949	SCREW, shoulder, DIA 8, M6	8
1402e	----	SCREW, M4 x 0.7-8, socket head, SST	2
1402f	----	PLATE, PR-X	1

* *Parts included in Kit 25R589 (purchase separately).*

† *Parts included in Kit 25R590 (purchase separately).*

♣ *Parts included in Kit 25R591 (purchase separately).*

Power Transmission Assembly

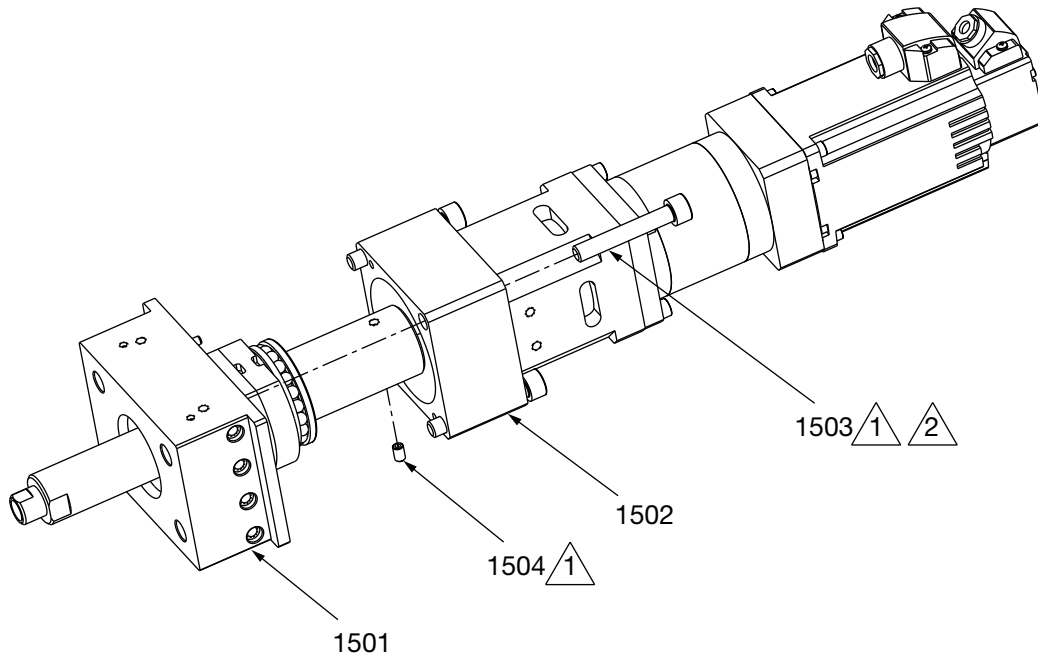

 Torque to 7.4-8.9 ft-lb (10-12 N•m).



 Apply sealant, Anaerobic, blue.

FIG. 48: Power Transmission Assembly

Ref.	Part	Description	Qty.
1501	----	ASSEMBLY, ball screw, see page 67	1
1502	----	PR-X Drive, see page 68	1
1503	18B956	SCREW, M8 x 1.25-50, socket head, Steel	4
1504	----	SCREW, SET, M5 x 0.8-8	2

Ball Screw Assembly

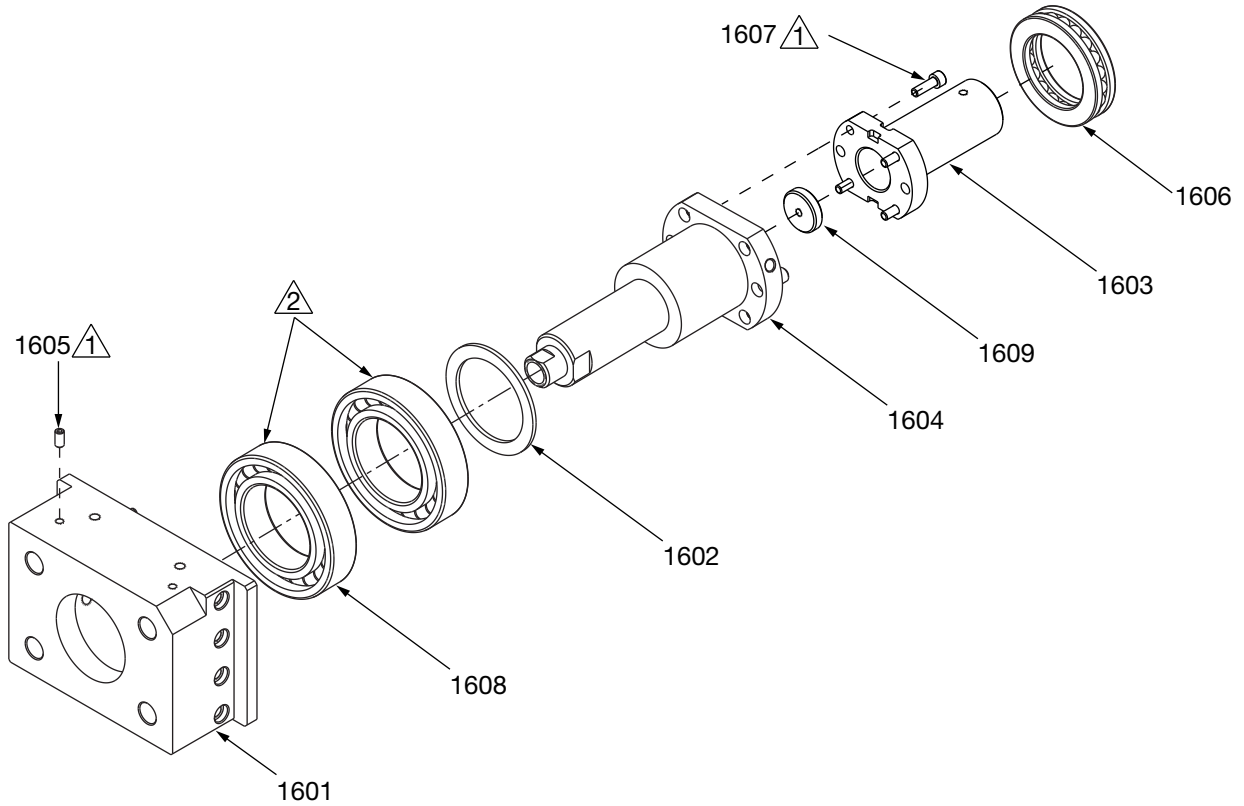

 Torque to 1.70-2.58 ft-lb (2.3-3.5 N•m).

 Open direction face to motor side.

FIG. 49: Ball Screw Assembly

Ref.	Part	Description	Qty.
1601	18D959	SEAT, sleeve	1
1602	18B962	WASHER	1
1603	18B963	COUPLER, lead screw	1
1604	25R237	ASSEMBLY, ball screw w nut	1
1605	18B950	SCREW, SET, M4 x 0.7-8	2
1606	18B969	BEARING, thrust	1
1607	18B970	SCREW, M5 x 0.8-16, socket head, SST	4
1608	18B971	BEARING, ball, angular contact	2
1609	2004550	GASKET, axle sleeve, PRX	1

PR-X Drive



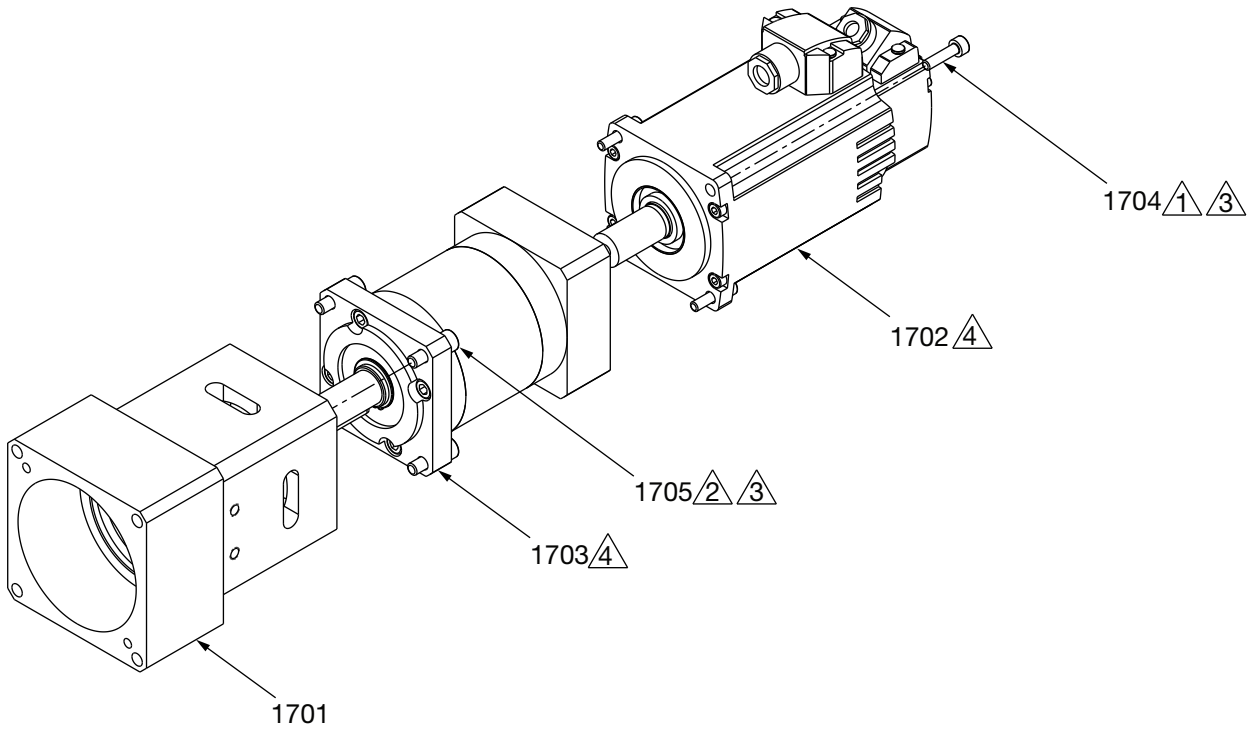



-  Torque to 3.69-4.79 ft-lb (5-6.5 N•m).
-  Torque to 5.53-5.90 ft-lb (7.5-8 N•m).
-  Apply sealant, Anaerobic, blue.
-  Installation direction as show.

FIG. 50: PR-X Drive

Ref.	Part	Description	Qty.
1701	18D972	SEAT, reduction	1
1702	18C019	MOTOR, servo, 3000 rmp, 220 V, 400 W	1
1703	18B973	GEAR REDUCER, 20:1	1
1704	18B974	SCREW, M4 x 0.7-16, socket head, SST	4
1705	18B970	SCREW, M5 x 0.8-16, socket head, SST	4

Supply Pump Assembly

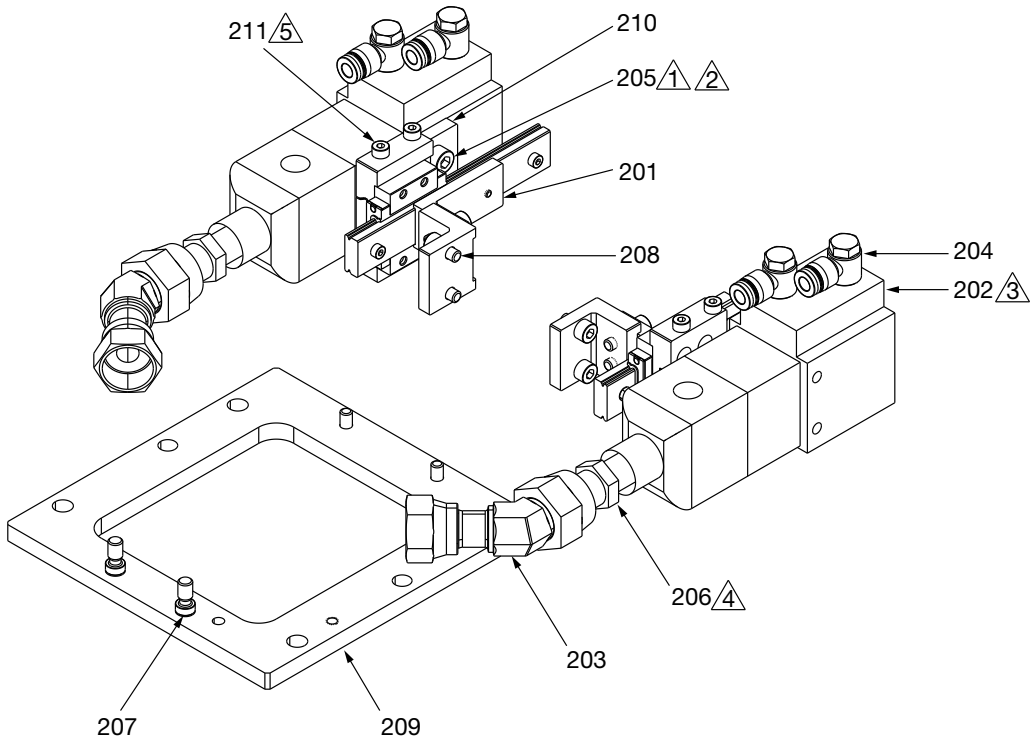

1 Torque to 3.0-3.7 ft-lb (4-5 N•m).

2 Apply sealant, Anaerobic, blue.

3 Adjust the fitting thread direction as shown.

4 Apply sealant, pipe, SST.

5 Torque to 0.74-1.11 ft-lb (1-1.5 N•m).

Fig. 51: Supply Pump Kit

Ref.	Part	Description
201†	----	ASSEMBLY, slide, pump, see page 70
202	243666	VALVE, 1K Ultra-Lite, SST
	2002912	VALVE, 1K Ultra-Lite, HW
203*	----	FITTING, UN13/16-16, male, female
204	18C103	FITTING, DIA 6, PT1/8, PV
205†	----	SCREW, 1/4 - 20 UNC, socket head
206*	----	FITTING, UN13/16-16, NPT1/4
207	18B951	SCREW, shoulder, DIA 8, M6
208	----	SCREW, M5 x 0.8-10, socket head, SST
209	18C106	PLATE, mounting, pump feed
210†	----	PLATE, mounting, valve
211†	----	SCREW, M4 x 0.7-20, socket
212✓	----	SCREW, set 1/4-28 x 0.313

Qty.						
25R128	25R129	2001180	2001181	2003138	2005007	2005008
2	2	2	2	2	2	2
2		2		2	2	
	2		2			2
2	2	2	2	2	2	2
4	4	4	4	4	4	4
4	4	4	4	4	4	4
2	2	2	2	2	2	2
2	2	2	2	2	2	2
6	6	6	6	6	6	6
1	1	1	1	1	1	1
2	2	2	2	2	2	2
4	4	4	4	4	4	4
1	1	1	1	1	1	1

* Parts included in Kit 25R592 (purchase separately).

† Parts included in Kit 25S151 (purchase separately).

✓ Part 212 is installed on Part 202, which is not shown on the sketch.

Pump Slide Assembly

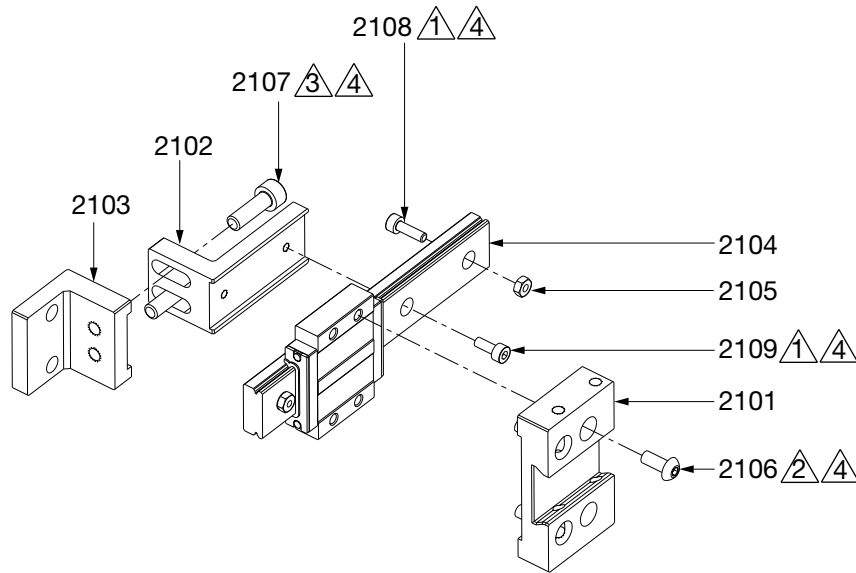





-  Torque to 0.74-1.29 ft-lb (1-1.75 N•m).
-  Torque to 1.70-2.85 ft-lb (2.3-3.5 N•m).
-  Torque to 3.0-3.7 ft-lb (4-5 N•m).
-  Apply sealant, Anaerobic, blue.

FIG. 52: Pump Slide Assembly

Ref.	Part	Description	Qty.
2101	18D770	PLATE, mounting, valve	1
2102	18D769	PLATE, mounting, slide	1
2103	18D768	PLATE, mounting, base	1
2104	18C097	RAIL, inlet valve, pump feed	1
2105	----	NUT, M3 x 0.5, THK2.4, SST	2
2106	----	SCREW, M4 x 0.7-10, button head, SST	4
2107	----	SCREW, M5 x 0.8-16, socket head, SST	2
2108	----	SCREW, M3 x 0.5-10, socket head, SST	2
2109	----	SCREW, M3 x 0.5-8, socket	2

Kits and Accessories

SD Card

Part	Description
2008299	Profinet Card, 4 MB

Cord set

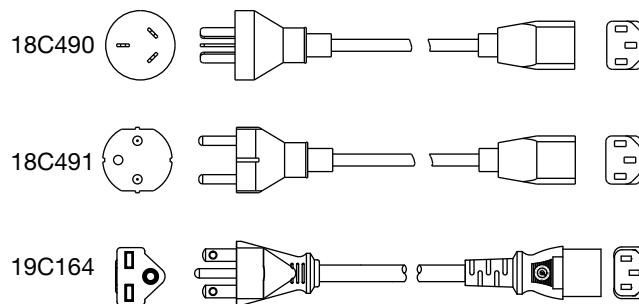

FIG. 53

Part	Description
18C490	CORD SET, 3 m, 015D-6/RWV, BK, 10 A, 250 V
18C491	CORD SET, 3 m, 010A/H05W-F, BK, 16 A, 250 V
19C164	CORD SET, US, 250 V, 10 A, 118 in. (3000 mm)

Cable

Part	Description
18C295	CABLE, 3 m, remote I/O connection
18C296	CABLE, 5 m, servo motor
18C297	CABLE, 5 m, servo encoder
18C298	CABLE, 5 m, start signal
18C299	CABLE, 5 m, pressure sensor, PR-X
18C300	CABLE, 5 m, junction box
2006623	CABLE, remote I/O, 10 m, PR-X
2006624	CABLE, servo power, 10 m, PR-X
2006625	CABLE, servo encoder, 10 m, PR-X
2006626	CABLE, start signal, 10 m, PR-X
2006627	CABLE, pressure sensor A, 10 m, PR-X
2006628	CABLE, pressure sensor B, 10 m, PR-X
2006629	CABLE, junction box, 10 m, PR-X

Mixer

Part	Description
2000546	MIXER, 05-24T
2000547	MIXER, 06-24T
2000548	MIXER, 10-24T
2000549	MIXER, 10-18T
2000550	MIXER, 13-24T
2000137	MIXER, 08-24T
2001498	MIXER, 05-32T
2001499	MIXER, 13-32T

Shroud

Part	Description
2000955	SHROUD, mixer, 08-24T, 7/8-9, AL
2000956	SHROUD, mixer, 13-24T, 7/8-9, AL
2000957	SHROUD, mixer, 10-24T, 7/8-9, AL
2000958	SHROUD, mixer, 10-18T, 7/8-9, AL
2000959	SHROUD, mixer, 06-24T, 7/8-9, AL
2000960	SHROUD, mixer, 05-24T, 7/8-9, AL

O-Ring

Part	Description
2001563	KIT, sealing, PR-X

Remote Kit

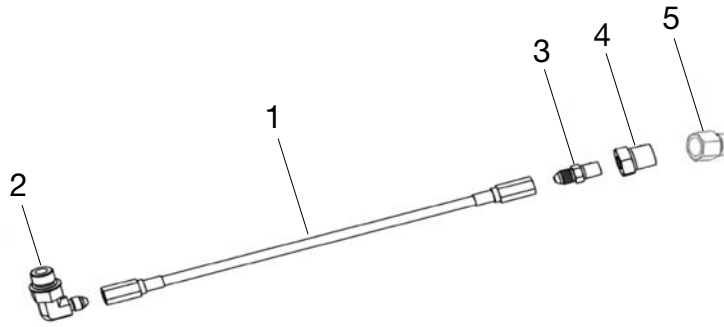

Fig. 54: Remote Kit

Part	Description	Reference Number and Description					
		1	2	3	4	5	
		Hose	Fitting	Fitting	Bushing	Bushing	
2001244	KIT, hose, ASSY, JIC fitting, PR-X, 3/16 x 36"	16C502	94/0144-S/25	94/1000/98	100329	18D958	
2001245	KIT, hose, ASSY, JIC fitting, PR-X, 3/16 x 48"	16C503					
2001246	KIT, hose, ASSY, JIC fitting, PR-X, 3/16 x 72"	16C504					
2001247	KIT, hose, ASSY, JIC fitting, PR-X, 1/4 x 36"	16C511	94/0148-S/25	124961	102022		
2001248	KIT, hose, ASSY, JIC fitting, PR-X, 1/4 x 48"	16C512					
2001249	KIT, hose, ASSY, JIC fitting, PR-X, 1/4 x 60"	24G990					
2001250	KIT, hose, ASSY, JIC fitting, PR-X, 1/4 x 72"	16C513					
2001251	KIT, hose, ASSY, JIC fitting, PR-X, 3/8 x 36"	16C520	94/0149-S/25	112100	504285		
2001252	KIT, hose, ASSY, JIC fitting, PR-X, 3/8 x 48"	16C521					
2001253	KIT, hose, ASSY, JIC fitting, PR-X, 3/8 x 60"	24F994					
2001254	KIT, hose, ASSY, JIC fitting, PR-X, 3/8 x 72"	16C522					
2001255	KIT, hose, ASSY, JIC fitting, PR-X, 1/2 x 36"	16C530	94/0150-S/25	C20700			
2001256	KIT, hose, ASSY, JIC fitting, PR-X, 1/2 x 48"	16C531					
2001257	KIT, hose, ASSY, JIC fitting, PR-X, 1/2 x 60"	24G996					
2001258	KIT, hose, ASSY, JIC fitting, PR-X, 1/2 x 72"	16C532					
2001277	KIT, hose, ASSY, ORFS fitting, PR-X, 3/8 x 72"	18C198	18C220	18C226			

Dimensions

PR-X Metering Unit, Pump Feed

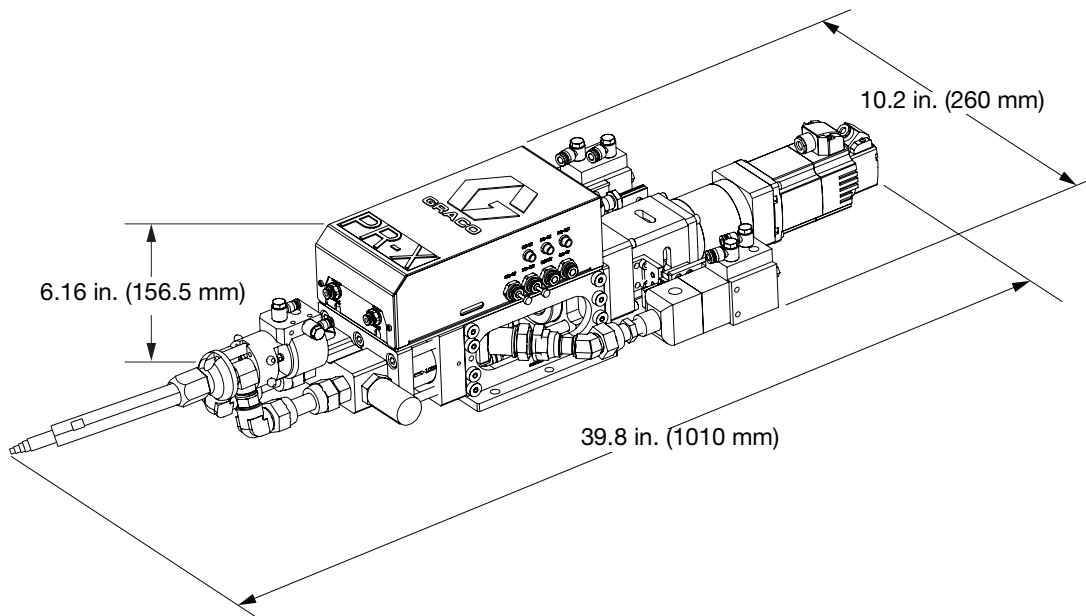

FIG. 55: PR-X Metering Unit Dimensions, Pump Feed

PR-X Control Unit

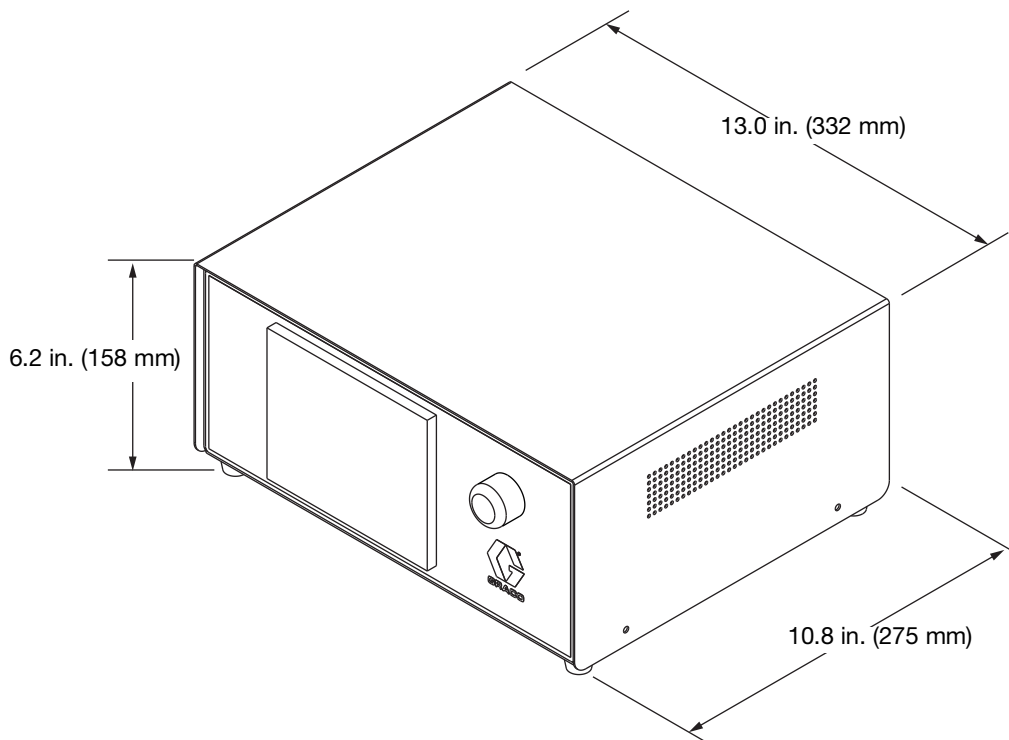

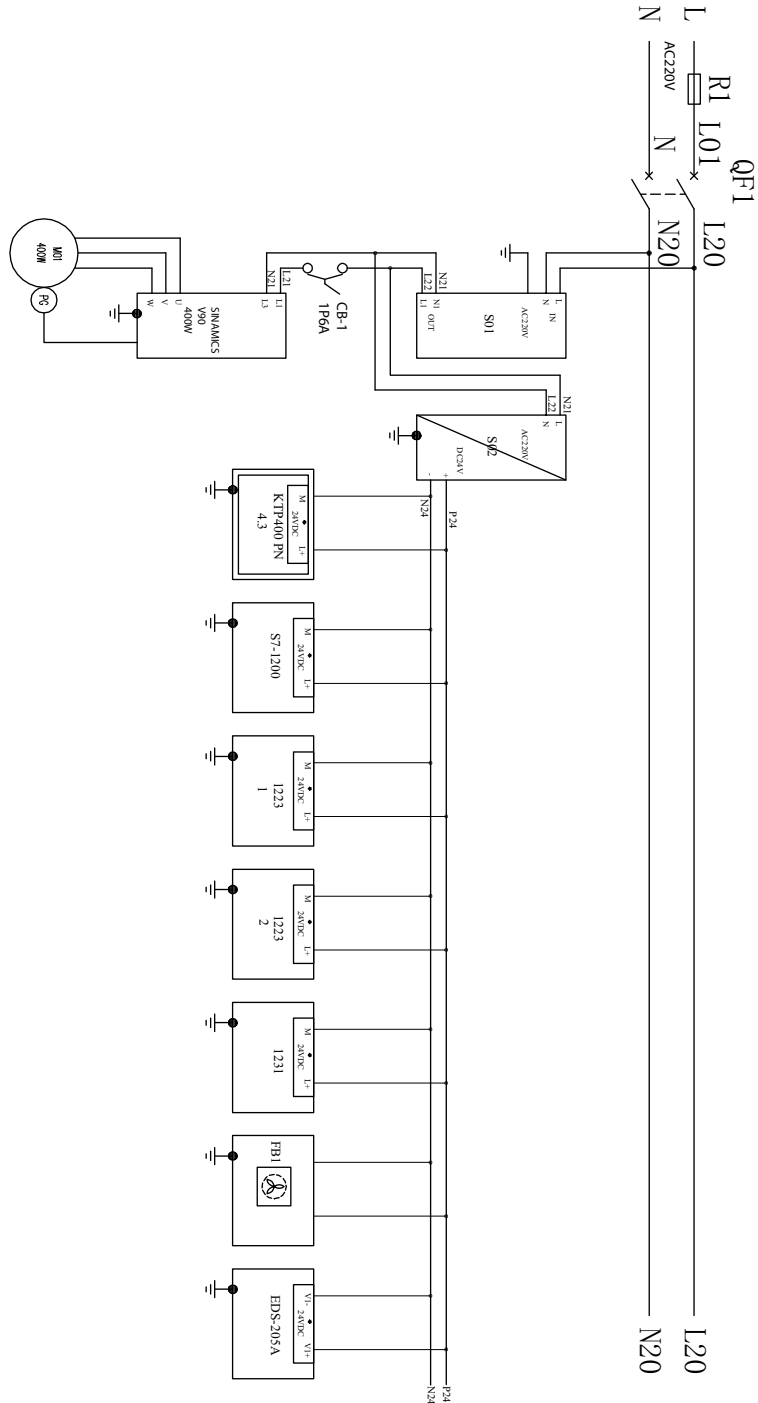
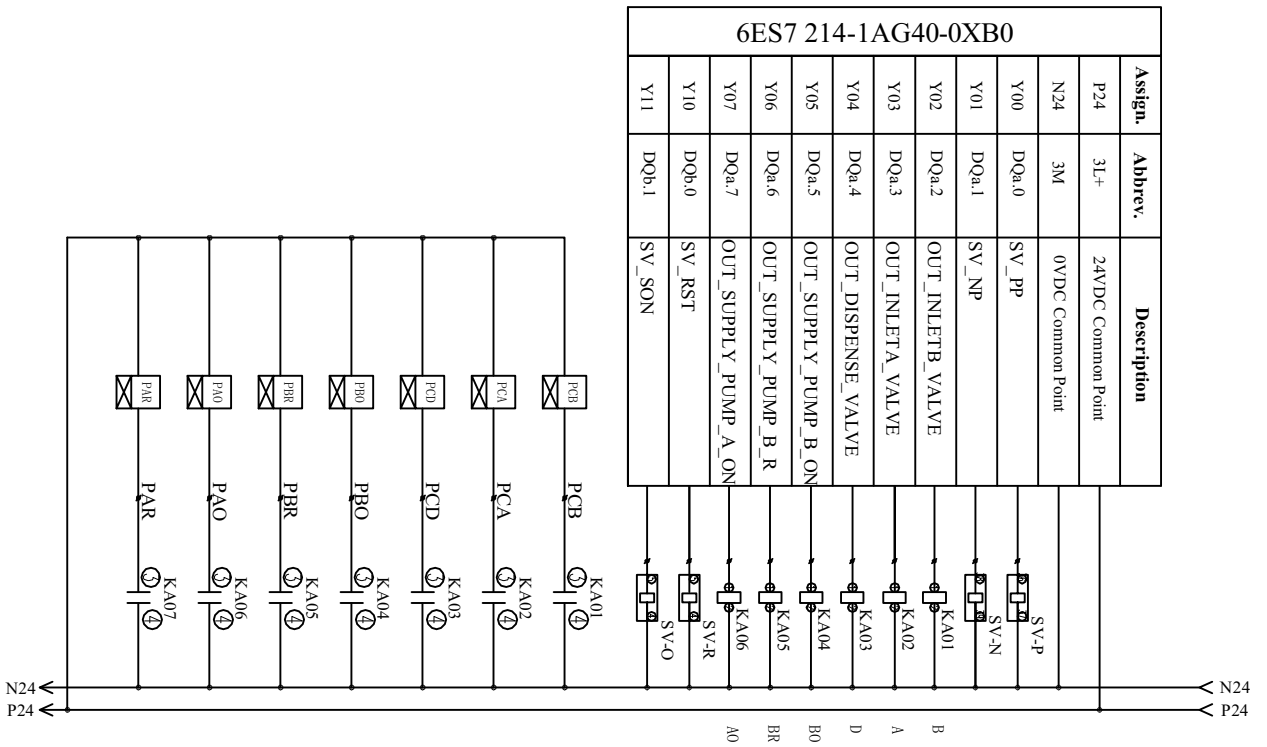
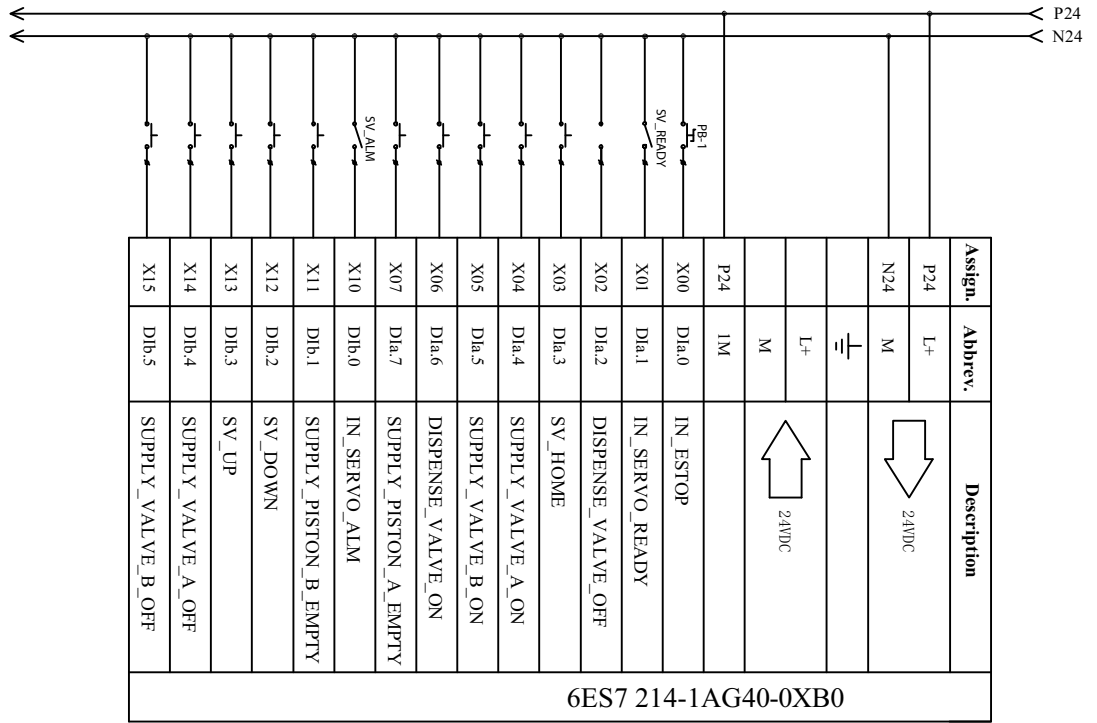

FIG. 56: Control Box Dimensions

Schematics

				
<p>All electrical wiring must be done by a qualified electrician and comply with all local codes and regulations.</p>				





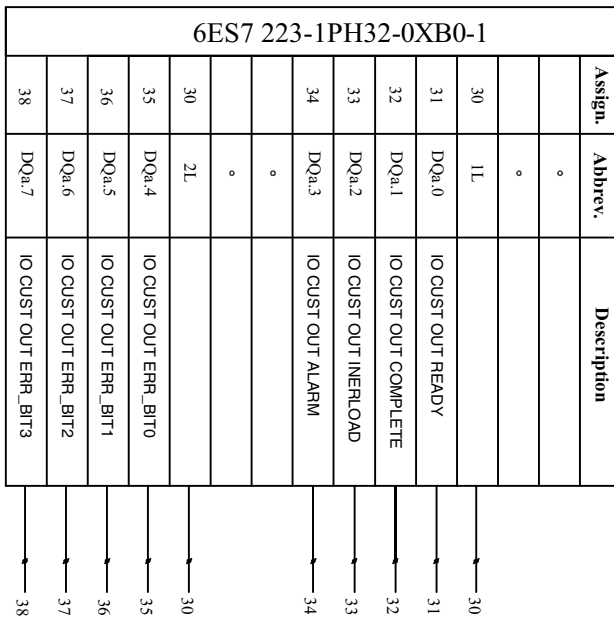
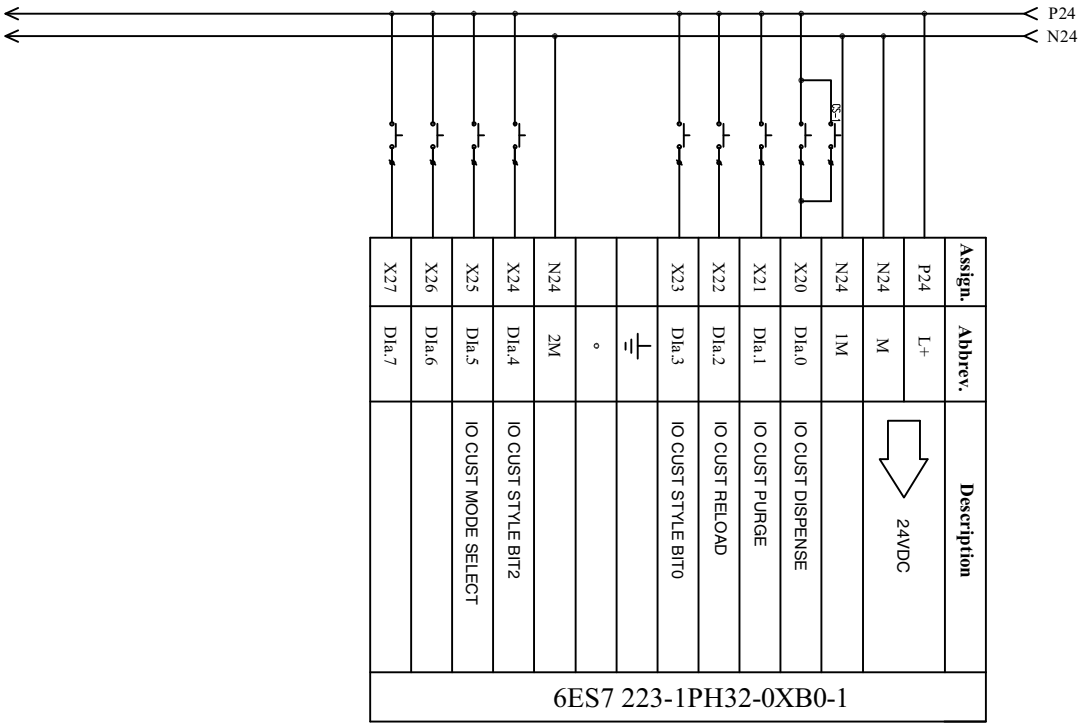

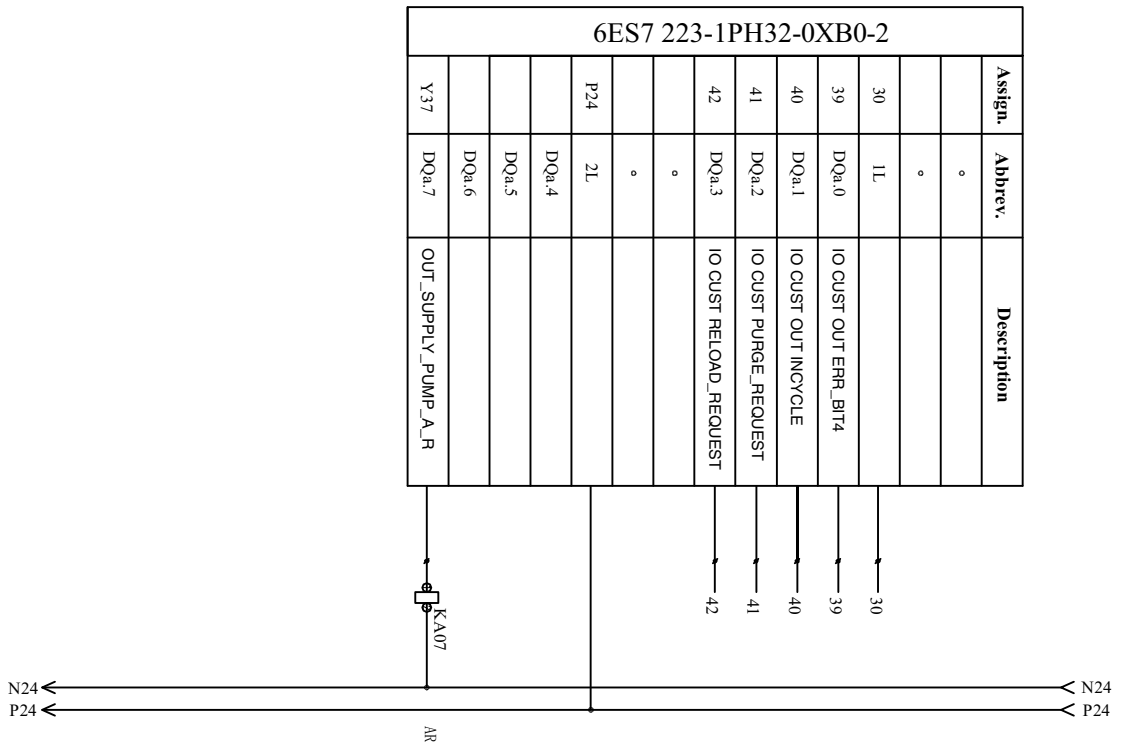
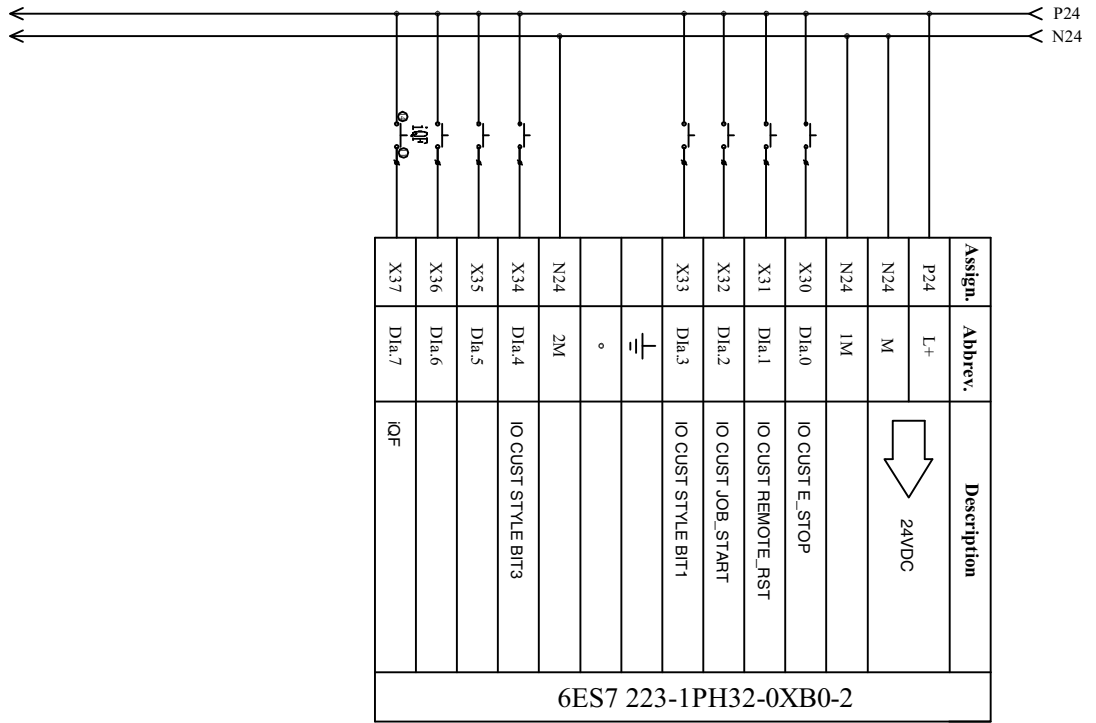

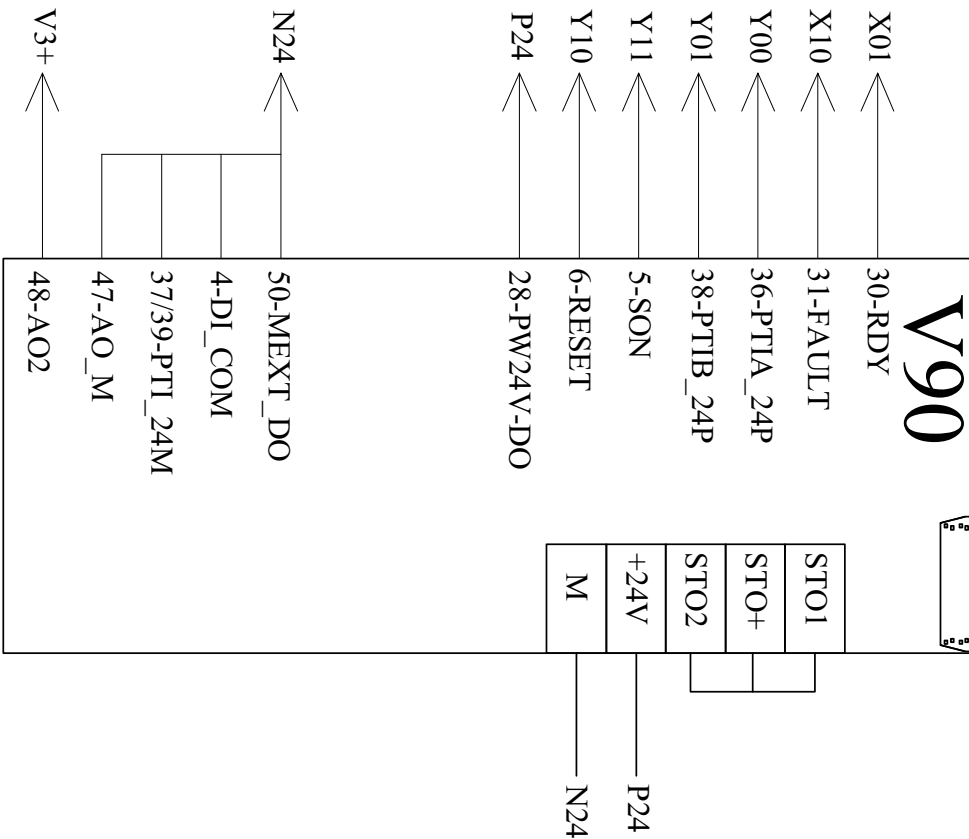
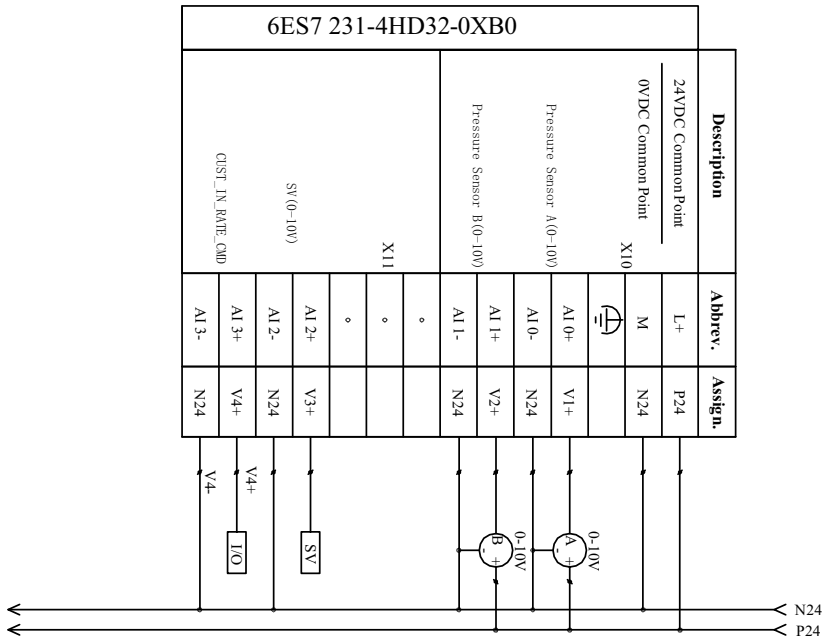

I/O signals

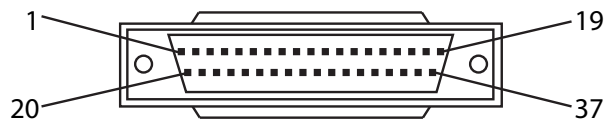

No.	Signal Style	I/O Pin No.	Mark	Color	Signal Name
1	Input	15	X32	Black	JOB_START
2		10	X20	Black Yellow	DISPENSE*
3		14	X22	Green Black	RELOAD
4		12	X21	Grey Black	PURGE
5		11	X30	Grey	E_STOP
6		13	X31	Green	REMOTE_RST
7		30	X26	Orange Blue	SYS_RELIEF
8		32	X27	Green Blue	SUPPLY_STOP
9		28	X25	Red Blue	MODE_SELECT
10		16	X23	Black White	STYLE BIT0
11		17	X33	Blue	STYLE BIT1
12		26	X24	Pink Black	STYLE BIT2
13		25	X34	Pink	STYLE BIT3
14		18	P24	Blue White	Input Common
15	Analog Input	33	V4+	Purple White	RATE_CMD+
16		34	V4-	Purple Blue	RATE_CMD-
17	Output	1	31	Brown	READY
18		2	32	Brown Black	STANDBY
19		3	33	Red	INRELOAD
20		4	34	Red Black	ALARM
21		5	35	White	ERR_BIT0
22		6	36	Brown White	ERR_BIT1
23		7	37	Orange	ERR_BIT2
24		8	38	Orange Black	ERR_BIT3
25		9	30	Yellow	Output Common
26		19	39	Light Blue	ERR_BIT4
27		20	40	Light Blue Black	INDISPENSE
28		21	41	Light Green	IN_JOB
29		22	42	Light Green Black	RELOAD_REQUEST

* The Start Signal Connection (BJ) is only connected to the "Start" signal, and its logic function is the same as the "Dispense" signal of the Remote I/O Connection (BC).

Profinet Map

Controller input from PLC output

Name	Units	In Byte	Description	
GATE_IN_CMD_BITS	0	JOB_START	1	Used to start job
	1	DISPENSE		Used to dispense in bead mode or shot mode
	2	RELOAD		Used to reload material
	3	PURGE		Used to purge
	4	REMOTE_RESET		Used to reset error
	5	MODE_SELECT		Used to set control mode in automatic 0 means shot mode 1 means bead mode
	6	SYS_RELIEF		Used to open dispense valve and relief pressure in metering system
	7	SUPPLY_STOP		Used to stop cartridge material supply
GATE_IN_NOTUSED		2	Not Used	
GATE_IN_STYLE_NO		3-4	0-15, used to select style	
GATE_IN_RATE_CMD		5-6	0-1000, used to control the dispense flowrate	

Controller output to PLC input

Name	Units	In Byte	Description	
GATE_OUT_STATUS_0	0	READY	1	
	1	INDISPENSE		
	2	COMPLETED		
	3	INRELOAD		
	4	PURGE_REQUEST		
	5	RELOAD_REQUEST		
	6	ALARM		
	7	STANDBY		
GATE_OUT_STATUS_1	0	INJOB	2	
	1	INPURGE		
GATE_OUT_ERR_CODE		3-4		
GATE_OUT_DISP_VOL		5-6	Integer, should multiply by 0.1, unit is cc	
GATE_OUT_JOB_VOL		7-8	Integer, should multiply by 0.1, unit is cc	
GATE_OUT_DISP_RATE		9-10	Integer, should multiply by 0.1, unit is cc	
GATE_OUT_PRESS_A		11-12	Integer, unit is psi	
GATE_OUT_PRESS_B		13-14	Integer, unit is psi	
GATE_OUT_MTR_TRQ		15-16	Integer, should multiply by 0.001, unit is NM	
GATE_OUT_DISP_RATIO		17-18	Integer, should multiply by 0.01	

Timing Chart

Reload after each job

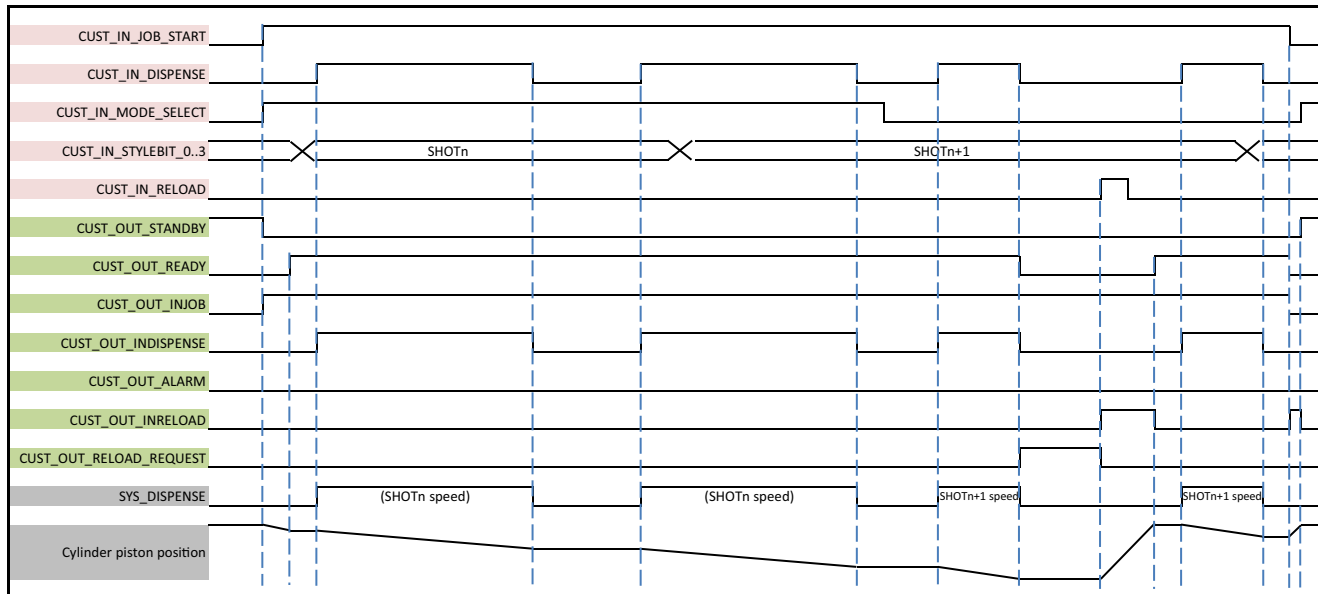

Reload after multi job

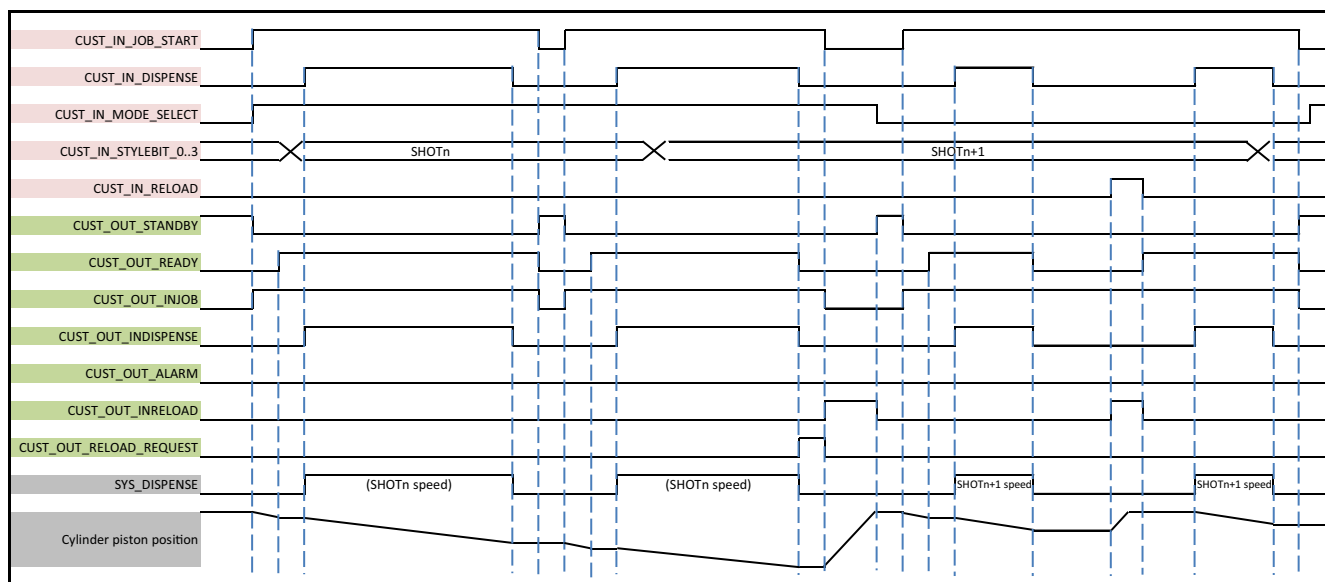

Technical Specifications

PR-X System		
	US	Metric
Maximum Inlet Fluid Pressure	1200 psi	8.3 MPa, 83 bar
Maximum Working Fluid Pressure	1200 psi	8.3 MPa, 83 bar
Maximum Air Pressure	100 psi	0.7 MPa, 7 bar
Weight	35 lb	16 kg
Electrical Power	200 - 240 VAC, 50/60 Hz, 10 A	
Viscosity Range	20 - 1,000,000 cps	
Wetted Parts	303/304 Stainless Steel, Hard Chrome, Ceramic, UHMWPE, NBR, Carbon Steel, PTFE	
Shot Size Repeatability	1 %	
Flowrate	0.01 - 25 cc/s (Depend on material viscosity)	
Maximum Working Temperature	158°F	70°C
Shot Size Range		
25R128 25R129 2005007 2005008	0.03 - 50 cc	
2001180 2001181	0.03 - 37 cc	
2003138	0.03 - 25 cc	
Inlet / Outlet Sizes		
Air Inlet size	1/4 in.	6 mm
Fluid Inlet size	1/4 in. npt (f)	
Fluid Outlet size	7/8-9 bell outlet	
Material Ratio⁽¹⁾		
25R128 25R129 2003138 2005007 2005008	1:1	
2001180 2001181	2:1	
Notes		
All trademarks or registered trademarks are the property of their respective owners.		

⁽¹⁾ If you want to order other ratio systems (1:1 - 2.4:1), please contact Graco sales representative for a custom solution.

California Proposition 65

CALIFORNIA RESIDENTS

 **WARNING:** Cancer and reproductive harm – www.P65warnings.ca.gov.

Graco Standard Warranty

Graco warrants all equipment referenced in this document which is manufactured by Graco and bearing its name to be free from defects in material and workmanship on the date of sale to the original purchaser for use. With the exception of any special, extended, or limited warranty published by Graco, Graco will, for a period of twelve months from the date of sale, repair or replace any part of the equipment determined by Graco to be defective. This warranty applies only when the equipment is installed, operated and maintained in accordance with Graco's written recommendations.

This warranty does not cover, and Graco shall not be liable for general wear and tear, or any malfunction, damage or wear caused by faulty installation, misapplication, abrasion, corrosion, inadequate or improper maintenance, negligence, accident, tampering, or substitution of non-Graco component parts. Nor shall Graco be liable for malfunction, damage or wear caused by the incompatibility of Graco equipment with structures, accessories, equipment or materials not supplied by Graco, or the improper design, manufacture, installation, operation or maintenance of structures, accessories, equipment or materials not supplied by Graco.

This warranty is conditioned upon the prepaid return of the equipment claimed to be defective to an authorized Graco distributor for verification of the claimed defect. If the claimed defect is verified, Graco will repair or replace free of charge any defective parts. The equipment will be returned to the original purchaser transportation prepaid. If inspection of the equipment does not disclose any defect in material or workmanship, repairs will be made at a reasonable charge, which charges may include the costs of parts, labor, and transportation.

THIS WARRANTY IS EXCLUSIVE, AND IS IN LIEU OF ANY OTHER WARRANTIES, EXPRESS OR IMPLIED, INCLUDING BUT NOT LIMITED TO WARRANTY OF MERCHANTABILITY OR WARRANTY OF FITNESS FOR A PARTICULAR PURPOSE.

Graco's sole obligation and buyer's sole remedy for any breach of warranty shall be as set forth above. The buyer agrees that no other remedy (including, but not limited to, incidental or consequential damages for lost profits, lost sales, injury to person or property, or any other incidental or consequential loss) shall be available. Any action for breach of warranty must be brought within two (2) years of the date of sale.

GRACO MAKES NO WARRANTY, AND DISCLAIMS ALL IMPLIED WARRANTIES OF MERCHANTABILITY AND FITNESS FOR A PARTICULAR PURPOSE, IN CONNECTION WITH ACCESSORIES, EQUIPMENT, MATERIALS OR COMPONENTS SOLD BUT NOT MANUFACTURED BY GRACO. These items sold, but not manufactured by Graco (such as electric motors, switches, hose, etc.), are subject to the warranty, if any, of their manufacturer. Graco will provide purchaser with reasonable assistance in making any claim for breach of these warranties.

In no event will Graco be liable for indirect, incidental, special or consequential damages resulting from Graco supplying equipment hereunder, or the furnishing, performance, or use of any products or other goods sold hereto, whether due to a breach of contract, breach of warranty, the negligence of Graco, or otherwise.

FOR GRACO CANADA CUSTOMERS

The Parties acknowledge that they have required that the present document, as well as all documents, notices and legal proceedings entered into, given or instituted pursuant hereto or relating directly or indirectly hereto, be drawn up in English. Les parties reconnaissent avoir convenu que la rédaction du présente document sera en Anglais, ainsi que tous documents, avis et procédures judiciaires exécutés, donnés ou intentés, à la suite de ou en rapport, directement ou indirectement, avec les procédures concernées.

Graco Information

Sealant and Adhesive Dispensing Equipment

For the latest information about Graco products, visit www.graco.com.

For patent information, see www.graco.com/patents.

TO PLACE AN ORDER, contact your Graco distributor, go to www.graco.com, or call to identify the nearest distributor.

If calling from the USA: 1-800-746-1334

If calling from Asia Pacific: 00-86-512-6260-5711 or 00-86-21-2310-6198

If calling from Europe: 00-32-89-770-862

All written and visual data contained in this document reflects the latest product information available at the time of publication. Graco reserves the right to make changes at any time without notice.

Original instructions. This manual contains English. MM 3A7526H

Graco Headquarters: Minneapolis

International Offices: Belgium, China, Japan, Korea

GRACO INC. AND SUBSIDIARIES • P.O. BOX 1441 • MINNEAPOLIS MN 55440-1441 • USA
Copyright 2020, Graco Inc. All Graco manufacturing locations are registered to ISO 9001.

www.graco.com
Revision H, February 2025